

Agronomic Aspects of Irrigated Crop Production

Developed by

Andreas P. SAVVA

and

Karen FRENKEN

Water Resources Development and Management Officers
FAO Sub-Regional Office for East and Southern Africa

In collaboration with

Fabeon CHIGUMIRA, Horticulturist Consultant

Harare, 2002

Contents

List of figures	v
List of tables	vi
List of abbreviations	vii
1. INTRODUCTION	1
1.1. Terminology used	1
1.2. Information on the climate in Zimbabwe	2
2. CROPPING PROGRAMME AND CROP ROTATION	5
2.1. Crop selection	5
2.2. Cropping pattern	5
2.3. Crop rotation	6
3. FERTILIZATION	9
3.1. Symptoms of nutrient deficiency	9
3.2. Chemical fertilizers	9
3.3. Organic manure	12
4. CONTROL OF PESTS, DISEASES AND WEEDS	13
4.1. Types of pests, diseases and weeds	13
4.1.1. Pests	13
4.1.2. Diseases	13
4.1.3. Weeds	13
4.2. Control measures	13
4.2.1. Preventive measures	13
4.2.2. Chemical control	15
4.2.3. Biological control	18
4.2.4. Hand and mechanical weeding	18
5. INTEGRATED PRODUCTION AND PEST MANAGEMENT (IPPM)	19
5.1. Description of IPM and IPPM	19
5.2. Farmers' Field Schools (FFS)	20
6. RAISING VEGETABLE SEEDS	21
6.1. Seed storage	21
6.2. Seed treatment	22
6.3. Germination and emergence	22
6.4. Improved seedbed management	23
6.4.1. Rotation	23
6.4.2. Soil sterilization	23
6.4.3. Seedbed preparation	24
6.4.4. Sowing the seeds	24
6.4.5. Thinning the seedlings	24
6.4.6. Weed, pest and disease control	24
6.4.7. Irrigation	24
6.4.8. Transplanting	24
6.4.9. Protected cultivation	25
6.4.10. Module propagation	25

7.	AGRONOMIC ASPECTS OF VEGETABLE CROPS	27
7.1.	Baby corn	27
7.2.	Bean (green, fine or string)	28
7.3.	Cabbage	29
7.4.	Carrot	30
7.5.	Cucum ber	31
7.6.	Garlic	32
7.7.	Okra	33
7.8.	Onion	34
7.9.	Paprika	35
7.10.	Pea	36
7.11.	Pea - Mange tout	37
7.12.	Potato	38
7.13.	Rape and Kale	39
7.14.	Squash - Pumpkin	40
7.15.	Tomato	41
7.16.	Watermelon	43
8.	AGRONOMIC ASPECTS OF FRUIT CROPS	45
8.1.	Apple and pear (pome fruits)	45
8.2.	Avocado pear	47
8.3.	Banana	49
8.4.	Citrus spp.	50
8.5.	Grape	53
8.6.	Mango	60
8.7.	Passion fruit (Maracuja, Grenadilla)	63
8.8.	Peach, plum, apricot and nectarine (stone fruits)	66
9.	AGRONOMIC ASPECTS OF FIELD CROPS	69
9.1.	Dry bean	69
9.2.	Groundnut	70
9.3.	Maize	71
9.4.	Rice	72
9.5.	Wheat	73
10.	PREPARATIONS NECESSARY FOR MARKETING OF HORTICULTURAL CROPS	75
10.1.	Characteristics of vegetables and fruits	75
10.1.1.	Seasonality	75
10.1.2.	Susceptibility to damage	75
10.1.3.	Perishability	75
10.1.4.	Diversity	75
10.2.	The relationship between producer, distributor and consumer	75
10.3.	Harvesting	75
10.4.	Storing the produce before marketing	76
10.5.	Packing and grading	76
10.6.	Transport	77
	REFERENCES	79

List of figures

1. Examples of insect pests	14
2. Examples of fungal diseases	15
3. Anthracnose on bean pods	29
4. Rust on a bean leaf	29
5. Aphids colonies on a cabbage leaf	30
6. Root-knot-nematode (RKN) attack on carrot	31
7. Powdery mildew on a carrot leaf (right), compared with a healthy leaf	31
8. Bacterial spot on paprika leaf and fruit	36
9. Downy mildew and powdery mildew on squash leaves	40
10. Root-knot-nematode attack in roots of tomato	42
11. Leaf spot on a tomato leaf	42
12. Fusarium on watermelon leaves	43
13. Pruning and staking of an apple tree during the 1st season	46
14. Scab on apple fruit	47
15. Fence trellis system for grapes	54
16. Perold trellis system for grapes	54
17. Slanting trellis system for grapes	55
18. Training and pruning of vines in which fruitful buds occur near base of the canes	57
19. Downy mildew on a grape leaf	59
20. Fruit rot (<i>Rhizopus</i> sp.) on grapes	59
21. Anthracnose on a mango leaf and fruit	62
22. Passion fruit high-density (intensive system) trellis plan: plan view	64
23. Passion fruit high-density (intensive system) trellis plan: side view	64
24. Passion fruit low-density (extensive system) trellis plan: side view	64
25. Passion fruit low-density (extensive system) trellis plan: cross-section	65
26. Groundnut leaf spot	71
27. Groundnut web blotch	71
28. Rice blast leaf lesions	72

List of tables

1.	Climatic data of some selected sites in Zimbabwe	3
2.	Climatic parameters for the agro-ecological zones in Zimbabwe	3
3.	Example of a crop calendar and cropping pattern	5
4.	Example of a crop rotation schedule	6
5.	Crop rotation frequency	6
6.	Host status of some vegetables crops for root-knot-nematodes: example from Zimbabwe	7
7.	Nutrient deficiencies and toxicities: generalized symptoms and circumstances	10
8.	Examples of deficiencies in several tropical crops	11
9.	List of some chemicals, their active substance and use	17
10.	Maximum moisture content of seeds to enable one year storage at different storage temperatures, as recommended by USDA	21
11.	Expected viability periods of seeds of various vegetables when stored under the conditions recommended in Table 10, according to the University of California	21
12.	Hot water treatment of seed for disease control	21
13.	Germination temperatures, time to germination and time required to produce a field viable transplant	21
14.	Vegetable grouping for rotational purposes	23
15.	Temperatures required to destroy pests in soil	23
16.	Recommended spacing for avocados	47
17.	Quantity of fertilizer in grams per year per avocado tree, according to age	48
18.	Cultivar, selection, commercial rootstocks, spacing and maturity dates for citrus in the high altitude areas	50
19.	Cultivar, selection, commercial rootstocks, spacing and maturity dates for citrus in the middle altitude areas	50
20.	Cultivar, selection, commercial rootstocks, spacing and maturity dates for citrus in the low altitude areas	51
21.	Fertilization guidelines for bearing trees in the absence of leaf and soil analysis, in grams/tree	52
22.	List of table grape cultivars	53
23.	Grapes fertilizer application programme	55
24.	List of stone fruit cultivars	67

List of abbreviations

AN	Ammonium Nitrate
B	Boron
BSM	Bean stem maggot
Ca	Calcium
Cl	Chloride
Cu	Copper
EC	Emulsifiable Concentrate
EPN	Entomopathogenic Nematodes
Fe	Iron
FFS	Farmers Field School
G	Granules
GV	Granulosis Virus
HV	Highveld (Zimbabwe)
IAC	International Agricultural Centre (Wageningen, the Netherlands)
IPM	Integrated Pest Management
IPPM	Integrated Production and Pest Management
K	Potassium
LD	Lethal Dose
LV	Lowveld (Zimbabwe)
Mg	Magnesium
Mn	Manganese
Mo	Molybdenum
MOP	Muriate of Potash
MV	Middleveld (Zimbabwe)
N	Nitrate
NPV	Nuclear Polyhedrosis Virus
O	Oxygen
P	Phosphorus
RKN	Root knot nematodes
S	Sulphur
SSP	Single Super Phosphate
TSS	Total Soluble Solids
WP	Wettable Powder
Zn	Zinc

Chapter 1

Introduction

This Module on agronomic aspects of irrigated crop production is meant as a quick reference for planners, extension officers or other agricultural field advisors who often need to give clear cut and immediate advice to farmers. It is not within the scope of this Module to provide the reader with complete information on the crops mentioned. For this, the reader is referred to literature specialized in the subject.

1.1 Terminology used

The crops described in this Module are limited to the most important crops being grown by smallholder farmers in East and Southern Africa. Several aspects are dealt with under each crop. They are briefly explained below:

Cultivar: A cultivar can be defined as ‘a variation of a species, one that has been produced through breeding or deliberate selection’. There are always new cultivars being bred, due to changes in taste by the population, the demand for higher yields, longer shelf life of the produce, resistance to pests and diseases, etc. Hence, there are always new varieties on the market. Names of some cultivars are given in this Module. It is best to check with the local seed companies as to what varieties are available and which one best suits prevailing conditions.

Climate and soil: This gives information on the types of climate and soil that are best suited to the crop under consideration.

Seed amount: The amount of seed required refers to sowing or planting by hand. Figures could therefore be higher than with mechanical sowing. The number of plants per hectare will in most cases be higher than under dryland conditions since crops under irrigation do not have to compete for water.

Spacing: This provides information on the optimum spacing of the seeds or transplants, between the rows and within the rows.

Planting time: Under irrigation the time at which a certain crop can be planted becomes more flexible. However, attention should be paid to the frost hazard during winter in high altitude areas and/or areas prone to frost and to very high temperatures during summer in low altitude areas. With higher flexibility planting dates can be more dictated by the market prices than by climate. Planting times mentioned in the text are general guidelines, indicating the period during which the cultivation of the crop has the best chance of success (based on the conditions in Zimbabwe).

Growth period: This is the time needed to grow and harvest a crop, based on facilities available to smallholder farmers. If the crop is first raised in seedbeds, the time required in the seedbed is stated. Depending on how the crop will be consumed, harvesting can in many occasions start earlier. For example, harvesting of green beans and green maize takes place earlier than harvesting of dry beans and grain maize.

Fertilizers: The most appropriate way of advising on fertilization is determined by the results of soil chemical analysis. However, since in many cases the extension worker or field advisor is obliged to give quick advice, general guidelines on compound fertilizers and on nitrogen topdressings are provided. Basal application means applying fertilizer into the soil before seeding or transplanting the crop. Topdressing means applying fertilizer to the soil or water surface after seeding or transplanting or after the crop has been well established. Chapter 3 provides more information on the different types of fertilizers.

Pests & diseases: Pests are insects, arachnids, rats, moles, snails that destroy crops, food or commodities, or interfere with human beings or animal. Diseases can be divided into infectious diseases, which are caused by living organisms called pathogens

(bacteria, fungi, viruses), and noninfectious diseases, which are caused by physiological disorders, environmental stress and damage by weather and other environmental factors. The identification of pests and diseases requires experience. It is a specialized field and it is advisable to call on the institution in the country that deals with Plant Protection or on the crop specialists to come to help. Some diseases, however, are quite common and can be easily detected by a keen observer. For these diseases the most characteristic features are described. Also indicated are the chemicals (fungicides, insecticides, acaricides, etc.) required to treat or prevent the pest or disease. While an actual trade name is given, a list of chemicals is provided in Chapter 4. Since smallholder farmers use knapsack sprayers, the amount of chemical needed is expressed in grams or ml per 10 litres of water. In most cases, a full cover spray is required and in the case of red spider mites and white fly special attention should be given to the underside of the leaves. More information on pest and disease control is given in Chapter 4. Chapter 5 presents the importance of integrated control, combining biological, mechanical and chemical controls.

Weed control: Weeds compete for water, nutrients and light with the effect of reducing crop development, which results in reduced yields. Weeds also harbor pests that damage crops, thus reducing quality. Keeping fields free of weeds, especially in the case of horticultural crops, is an essential cultural operation. Although some herbicides are available, few are registered for application on vegetables. Care should be exercised when using herbicides as some have long residual effects that may affect subsequent crops. Hand weeding is the cheapest method and weeds are easy to control at the early stages of development (Chapter 4).

Crop rotation: Many problems caused by pests and diseases can be prevented by correct crop rotation (Chapter 2).

Crop data & irrigation requirements: Crop data, like length of growth stage, crop coefficient, rooting depth, depletion level and the yield-response factor, are necessary for each growth stage in order to be able to calculate the crop water and irrigation requirements using the FAO-CROPWAT computer programme. These

crop data and the irrigation requirements and scheduling are, however, not described in this Module. The reader is referred instead to Module 4, which specifically deals with crop water requirements and irrigation scheduling.

1.2. Information on the climate in Zimbabwe

The crop information given in Chapters 7, 8 and 9 serves as a guideline only and is based on the climatic conditions prevailing in Zimbabwe. This information will need to be adapted for other countries in the sub-region if the climatic conditions are different. Below is a short description of the climate in Zimbabwe.

In the northern and southern hemisphere, between the latitudes of about 25 and 45°, there is a zone known as the subtropical high-pressure belt. This belt contains several separate high-pressure cells (also known as anticyclones). This zone is the subsiding arm of the Hadley Cell, a north-south circulation of air in the low latitudes, consisting of two opposing cells, each having air rising in the intertropical convergence zone (around the equator) and sinking in the subtropical high-pressure belt. Regions between these belts do not experience the traditional Spring-Summer-Autumn-Winter sequence of temperate latitudes, though there is some similarity. Zimbabwe, being north of the southern subtropical high-pressure belt, does not therefore experience the traditional seasons. The country has four seasons:

- ❖ The *cool season* between mid-May and mid-August: This is the time of the year when the lowest temperatures are recorded (winter). It coincides with the dry season. Daytime temperatures are in the range of 20-29°C, while cold to very cold minimum temperatures are in the range 4-12°C. When the air is sufficiently dry as well as in places with high altitude (> 1 000 m above sea level), scattered early morning ground frost is common.
- ❖ The *hot season* between mid-August and mid-November: The rise in the relative humidity results in the increase in the night temperatures and a reduction in the risk of ground frost. The highest temperatures usually occur in the latter half of October or early November with an average maximum temperature in the range of range 26-35°C. Occurrence of severe thunderstorms is common towards the end of the hot season, that is mid-November, which marks the end of the dry season.

- ❖ The *main rainy season* between mid-November and mid-March:

The end of the hot season marks the start of the main rainy (summer) season, though the dates do vary considerably. An annual rainfall in the excess of 1 500 mm is common, but in the south and southeast it is only around 500 mm. This also shows a stronger association of rainfall with elevation, for high altitude areas in the eastern part of the country receiving an average of 3 000 mm annually.

- ❖ The *post-rainy season* from mid-March to mid-May:

This season sees the gradual establishment of the dry and cool winds. Daytime temperatures start showing a downward trend and there is a marked decrease in night temperatures. The weather is generally mild and sunny with a maximum average temperature range of 23-31°C.

Table 1 presents climatic data of some selected sites in Zimbabwe, while Table 2 summarizes the average climatic parameters for the Lowveld (LV), Middleveld (MV) and Highveld (HV) regions in Zimbabwe.

Table 1
Climatic data of some selected sites in Zimbabwe

Month	J	F	M	A	M	J	J	A	S	O	N	D
Station	Beitbridge: 457 m above sea level (Lowveld)											
Day-length (hours)	13.3	12.8	12.2	11.6	11.1	10.8	10.9	11.4	12.0	12.6	13.2	13.4
24-hour mean temp. (°C)	27.1	26.6	25.6	23.2	19.7	16.5	16.7	19.3	22.7	25.4	26.2	26.7
Station	Bulawayo: 1 315 m above sea level (Middleveld - Highveld)											
Day-length (hours)	13.2	12.7	12.2	11.7	11.2	10.9	11.1	11.4	12.0	12.5	13.0	13.3
24-hour mean temp. (°C)	21.2	20.7	20.1	18.5	15.8	13.3	13.6	16.1	19.5	22.0	21.3	21.1
Station	Harare: 1 479 m above sea level (Highveld)											
Day-length (hours)	13.1	12.7	12.2	11.7	11.3	11.1	11.2	11.5	12.0	12.5	12.9	13.2
24-hour mean temp. (°C)	20.0	19.8	19.4	18.1	15.6	13.3	13.2	13.3	18.4	20.9	20.5	20.1
Station	Karoi: 1 345 m above sea level (Middleveld - Highveld)											
Day-length (hours)	13.0	12.6	12.2	11.7	11.3	11.1	11.2	11.5	12.0	12.5	12.9	13.1
24-hour mean temp. (°C)	20.2	20.1	19.8	18.9	16.8	14.7	14.6	16.8	19.9	22.5	21.7	20.6
Station	Nyanga: 1 878 m above sea level (Highveld)											
Day-length (hours)	13.1	12.7	12.2	11.7	11.3	11.1	11.1	11.5	12.0	12.5	13.0	13.2
24-hour mean temp. (°C)	16.4	16.2	15.5	14.2	12.2	10.3	09.9	11.7	14.3	16.2	16.1	16.2
Station	Sabi valley: 448 m above sea level (Lowveld)											
Day-length (hours)	13.2	12.7	12.2	11.6	11.2	10.9	11.0	11.4	12.0	12.6	13.1	13.3
24-hour mean temp. (°C)	25.6	25.1	24.2	22.4	19.3	16.5	16.6	19.1	22.3	25.1	25.8	25.5

Table 2
Climatic parameters for the agro-ecological zones in Zimbabwe

Climatic Parameter	Agro-ecological zone		
	Lowveld	Middleveld	Highveld
Altitude above sea level (m)	< 600	600-1 200	> 1 200
Average annual rainfall (mm)	< 450	400-800	> 750
Annual temperature: Mean maximum (°C)	30	25	20
Mean minimum (°C)	16	12	10

More detailed climatic information is given in Module 4.

Chapter 2

Cropping programme and crop rotation

Cropping intensity and production potential are in general higher for crops under irrigation than for crops under dry-land farming. This calls for a balanced cropping programme, a sound rotation and strict plant protection measures.

When designing an irrigation scheme, the preparation of cropping programmes is the first step in calculating crop water requirements. Based on this, the capacity of the irrigation system and the area to be covered by the system can be determined, taking into consideration the water availability.

2.1. Crop selection

Besides water availability, other important factors to consider in crop selection are prevailing climatic conditions and soils, the farmer preference and marketing potentials. These affect the choice of crops and crop varieties and the planting time. Labour requirements and availability, market distances and needs, transport costs and reliability, and measures to combat pests and diseases must also all be considered as they determine the scale and frequency of production. These factors are often site-specific, which must be taken into cognizance when a farmer produces different crop varieties.

Neither cropping programmes nor agronomic recommendations are fixed and this should therefore be taken into consideration when designing the irrigation systems. For design purposes, a cropping pattern should be made in such a way that the farmers would be able to grow and irrigate all of their crops adequately. This involves careful investigation and planning, considering all factors

mentioned earlier, and in-depth discussions with all farmers involved.

When a certain water supply is given, cropping patterns may need to be adjusted to avoid peak irrigation requirements at periods of high evaporative demand and to avoid peak requirements of various crops occurring simultaneously. This includes consideration of shifting the sowing or planting dates, taking into account climatic constraints in a given area, manipulating the length of growing seasons by use of different crops and cultivars, and knowing sensitive crop stages in order to avoid yield reduction due to water stress during the critical period.

2.2. Cropping pattern

Once the crops have been selected, one can make up the seasonal cropping pattern indicating the place and the occupying area of each crop. A cropping programme diagram as shown in Table 3 is very useful. This diagram helps in establishing which crop will occupy what part of the available area during each season, also taking into consideration the crop rotation requirements (Section 3.2).

While the time needed for land preparation and for harvest should not be included when calculating the crop water requirements, it is useful to indicate on the cropping programme diagram the time needed for so doing. Planting or transplanting dates, the length of the period that the crop will be in the ground, the time and conditions needed for harvest as well as for land preparation for the next crop are all important. Repeating this for the next season gives a clear picture of the yearly cropping pattern.

Table 3
Example of a crop calendar and cropping pattern

Crop	Jan	Feb	Mar	Apr	May	June	July	Aug	Sept	Oct	Nov	Dec
Maize	————— 26									15 —————		
Beans	1 —————			30								
Cabbages	————— 15											1 ———
Groundnuts	————— 15									20 —————		
Wheat					15 —————				30			
Onions					1 —————				25			
Green maize								1 —————				16
Potatoes					1 —————				15			

2.3. Crop rotation

The place occupied by the different crops during consecutive years makes up the crop rotation (Table 4). In order to reduce the risk of pests and diseases and to maintain soil fertility, crops are rotated within the field in such a way that crops belonging to the same family do not occupy the same area during consecutive years as they share same pests and diseases. Of special concern are crops susceptible to nematodes. In this case, a rotation cycle of minimum four years is required. Examples are tobacco, tomato, potato, eggplant, chilli (all of the *Solanaceae* family), okra and carrot.

A heavily nematode-infested soil will reduce the growth and yield of a whole range of crops grown on this soil. Cotton and onion are known to be good cleaning crops when grown prior to and following crops that are susceptible to nematodes. It is recommended that the stubble of susceptible crops be uprooted and burnt. Besides cotton and onion, some flowers, for example the marigold, have a nematode population reducing effect. Nowadays, chemicals are also available to control nematodes by soil

treatment. However, these chemicals are quite expensive and very toxic. Their application requires expertise and know-how. The cheapest and most effective preventive control against nematodes is an adequate crop rotation. The degree of nematode infestation will be a guide to determining which control method to opt for.

Table 5 gives a rough indication of the rotation frequency of some crops.

Table 6 shows a number of vegetable crops that have been grouped according to their susceptibility to nematodes. It shows that crops from the onion family (*Alliaceae*) are, in general, tolerant of nematodes.

As nematode activity is reduced to a low level between May and September in the high altitude areas (> 1 000 m above sea level), it is quite safe to plant susceptible crops from group A during this time as long as they do not precede summer-grown susceptible crops. In low altitude areas (< 1 000 m above sea level) nematodes are active all year round and susceptible crops can only be grown once every four years.

Table 4
Example of a crop rotation schedule

Summer 1	Winter 1	Summer 2	Winter 2	Summer 3	Winter 3	Summer 4	Winter 4
Maize	Onions	Groundnuts	Potatoes	Cabbages	Green maize	Beans	Wheat
Beans	Wheat	Maize	Onions	Groundnuts	Potatoes	Cabbages	Green maize
Cabbages	Green maize	Beans	Wheat	Maize	Onions	Groundnuts	Potatoes
Groundnuts	Potatoes	Cabbages	Green maize	Beans	Wheat	Maize	Onions

Table 5
Crop rotation frequency

Crop	Frequency (Number of years)	Crop	Frequency (Number of years)
Beans	2	Potatoes	4
Cabbages	2	Rape, kale	2
Carrots	2	Sorghum	2
Cotton	1-2	Soya beans	2
Cucurbit	3	Sunflowers	4-6
Eggplants	4	Tobacco	4
Groundnuts	2	Tomatoes	4
Okra	4	Wheat	2
Pepper	4		

Table 6

Host status of some vegetable crops for root-knot-nematodes (R.K.N.): example from Zimbabwe

Group A: Susceptible crops	Group B: Tolerant crops	Group C: Resistant crops
<i>Chenopodiaceae</i>	<i>Cruciferae</i>	<i>Alliaceae</i>
Beetroot	Broccoli	Garlic
Swiss chard	Brussels sprouts	Leek
	Cabbage	Onion
<i>Compositae</i>	Cauliflower	Shallots
Lettuce	Kale	
	Rape	
<i>Cucurbitaceae</i>	Radish	
Cucumber	Tsunga	
Gourd	Turnip	
Melon		
Pumpkin	<i>Convolvulaceae</i>	
Squash	Sweet potato	
<i>Labiatae</i>	<i>Solanaceae</i>	
Tsenza	Chilli pepper	
<i>Leguminosae</i>	<i>Graminae</i>	
Bambara nut	Maize	
Broad bean	Sweet corn	
Cowpea		
Pea		
Sugar bean		
<i>Malvaceae</i>		
Okra		
<i>Solanaceae</i>		
Eggplant		
Irish potato		
Sweet pepper		
Tomato		
<i>Umbelliferae</i>		
Carrot		
Celery		
Parsley		

Note: Susceptible crops: good hosts for RKN. Tolerant crops: poor hosts for RKN. Resistance crops: non-hosts for RKN.

Chapter 3

Fertilization

Fertilizers are used to increase crop production by adding to the soil those nutrients that are in short supply and to restore and maintain the soil fertility, since a large percentage of plant nutrients is removed from the soil with harvesting.

3.1. Symptoms of nutrient deficiency

Nutrient deficiencies are one of the most common ways in which land degradation affects production. Therefore, it is essential for the field assessor to be aware of the evidence of such deficiencies in growing plants. In most cases, by the time nutrient deficiencies are evidenced by abnormalities in the visual presentation of a plant, it is already too late to correct the deficiency in time to affect current yields. Nevertheless, if future productivity is to be maintained or increased, it is important to identify, as far as is possible, the cause of the abnormalities (Stocking and Murnaghan, 2000). In Table 7 some of the conditions that can lead to nutrient deficiencies and toxicities are noted.

The observation of abnormalities in plants is a complicated and skilled task. Since nutrient deficiencies may be manifested in different ways, depending on the crop in which they occur, particular criteria will be crop-specific. As an example, the visual indicators of nutrient deficiencies in several tropical crops are set out in Table 8.

3.2. Chemical fertilizers

Usually only the three primary plant nutrients are provided, which are Nitrogen (N), Phosphorus (P) and Potassium (K). The corresponding units for expressing fertilizer needs are:

N = Nitrate

P_2O_5 = Phosphorus pentoxide

K_2O = Potash

An important secondary nutrient is Sulphur (S), which is present in many fertilizers. The secondary nutrient Calcium (Ca) may be present in certain fertilizers. In very special cases, trace elements such as Boron (B) are incorporated in fertilizers.

Distinction is made between 'straight' fertilizers, containing one of the primary elements only, 'incomplete mixtures', containing two elements (N+P, N+K or P+K), and

'complete mixtures', containing all three elements. These last are called 'Compound fertilizers' in this Module. Examples of straight fertilizers are:

- ❖ Nitrogenous fertilizer: Ammonium Nitrate:
 NH_4NO_3 with 34.5% N
- ❖ Phosphatic fertilizer: Single Super Phosphate:
14-20% water soluble P_2O_5 in $Ca(N_2PO_4)_2 \cdot H_2O + CaSO_4 \cdot 2H_2O$
- ❖ Potash fertilizers: Muriate of Potash:
60% K_2O

The following Compound fertilizers can be found:

- ❖ Compound C = 6 : 17 : 15
(6% N, 17% P_2O_5 , 15% K_2O)
- ❖ Compound D = 8 : 14 : 7
(8% N, 14% P_2O_5 , 7% K_2O)
- ❖ Compound J = 15 : 5 : 20
(15% N, 5% P_2O_5 , 20% K_2O) + 3.4% S + 0.04% B
- ❖ Compound L = 5 : 18 : 10
(5% N, 18% P_2O_5 , 10% K_2O) + 0.25% B
- ❖ Compound S = 6 : 17 : 6
(6% N, 17% P_2O_5 , 6% K_2O) + 0.04% B + 9% S

Complete mixtures are the most expensive per nutritive unit, but they are easier to apply with less chance of mistakes compared to 'straights'. They are very popular with inexperienced users, since the presence of just one or two nutritive components is enough to bring about a significant yield increase. They can be used as 'all-purpose mixtures' for smallholders engaging in commercial production and home gardening of food crops, vegetables and fruit trees (Euroconsult, 1989).

In general, there are two methods of fertilizer application:

- ❖ Uniform distribution over the whole area (broadcasting)
- ❖ Localization of the fertilizer in strips (bands) or in pockets (placement)

For pressurized systems fertilizers can be applied through the irrigation water. For this purpose only water-soluble fertilizers can be used. For details on this practice, called fertigation, the reader is referred to Module 9.

Table 7

Nutrient deficiencies and toxicities: generalized symptoms and circumstances (Source: Stocking and Murnaghan, 2000)

Essential Nutrient	Deficiency/Toxicity Symptoms	Typical Conditions
Nitrogen (N)	Leaves (first older ones) turn yellow/ brown, plants are spindly, lack vigour and may be dwarfed	Sandy soils under high rainfall conditions and soils low in organic matter, where leaching occurs
Phosphorus (P)	Not easily detected from appearance. Where deficiency is severe plant will be stunted, the leaves will take on a purplish tint and the stem will be reddish in colour	Acid soils rich in iron and aluminium oxides (i.e. red tropical soils)
Potassium (K)	Yellow/brown spots appear on older leaves and/or necrosis of edges	More frequent on light soils (as K is concentrated in the clay fraction of soils)
Sulphur (S)	Leaves are stunted, with uniform chlorosis	
Calcium (Ca)	Roots are usually affected first – growth is impaired and rotting often occurs. In vegetative growth, deficiency may show in distorted leaves, brown scorching or spotting on foliage or bitter fruit (e.g. apple) or blossom-end rot (e.g. tomato)	Acid soils, or alkali or saline soils containing high proportions of sodium
Magnesium (Mg)	Interveinal chlorosis, first on older leaves	Acid, sandy soils in areas with moderate to high rainfall. Often occurs in conjunction with Ca deficiency
Iron (Fe)	Chlorosis of younger leaves	Calcareous soils, poorly drained and with high pH. (In neutral and alkaline soils P may prevent the absorption of Fe)
Manganese (Mn)	Chlorosis of younger leaves	Badly drained soils, over-liming or deep ploughing of calcareous soils can lead to Mn deficiency, as can the presence of high levels of Mg. The combination of high pH values (> 6.5) and high levels of organic matter can immobilize soil Mn
Zinc (Zn)	Symptoms vary with plant type – in cereals young plants display purpling, whereas in broad-leaved plants symptoms include interveinal chlorosis, reduced leaf size and sparse foliage	Soils with high pH. Available Zn is reduced by the application of lime or phosphates
Copper (Cu)	Chlorosis of the tips of the youngest leaves and die-back of growing points	Peat soils, or leached sandy or acid soils
Boron (B)	In crops other than cereals, the apical growing point on the main stem dies and lateral buds fail to develop shoots. Legumes (beans, peas) are very sensitive to Boron deficiency	Sandy soils, dry conditions and liming can result in B deficiency
Molybdenum (Mo)	Marginal scorching and cupping of leaves. Wilting is common in Brassicas. Cereals and particularly maize are sensitive to Molybdenum deficiency	Acid soils or soils with high pH. Mo deficiency can lead to N-deficiency, as nitrate requires adequate supplies of Mo for metabolism. Mo availability can inhibit the uptake of Cu
Chlorine (Cl)	Wilting of leaves	Well-drained, sandy soils
Sulphur toxicity		Build up of sulphates as a result of irrigation
Manganese toxicity	Brown spots and uneven chlorophyll in older leaves	Soils with pH of < 5.0 (for susceptible species)
Copper toxicity	Chlorosis of leaves and restricted root growth	Soils with low pH
Boron toxicity	Progressive necrosis of the leaves, starting from the tips and/or margins	Soils with low pH
Aluminium toxicity	Plants die after early growth	Acid mineral soils, aggravated by low P status
Chlorine toxicity	Burning of leaf tips, bronzing and premature yellowing of leaves	Associated with irrigation using water containing chloride

Table 8**Examples of deficiencies in several tropical crops (Source: Stocking and Murnaghan, 2000)**

	Maize	Beans	Cabbage
General	High N requirement and sensitive to low phosphate supply. Relatively sensitive to water stress.	Tolerant to a wide range of conditions, but only high yielding with high N	Demanding of N, P and K. Moderately sensitive to water stress
Nitrogen	Reduced vigour; leaves a pale green or yellowish colour	Plants are small, leaves are pale green and older leaves turn yellow. Few flowers are produced	Young leaves pale green, older leaves are orange, red or purple. Severe deficiency renders the crop useless
Phosphorus	Stunted growth, delayed ripening and purplish leaf colour, especially during early growth	Stems are dwarfed and thin, leaves lack lustre. Early defoliation occurs, starting at base of shoot	Leaves are dull green with purplish tinge, margins die
Potassium	Small whitish-yellow spots on leaves. Poor root system, plants are weak and may be blown down	Chlorosis of leaves, with necrotic brown patches at margins between veins	Leaves are bluish-green. Leaf margins may show scorching and tips of older leaves may die
Sulphur	Somewhat similar to N deficiency. Plants short and spindly. Younger leaves pale beige to straw in colour	Stunted growth, yellowing leaves. Delayed flowering and development of beans. Reduced nodulation on roots	Smaller plants, with yellowing leaves
Calcium	Poor germination and stunted growth	Growth is stunted and growing point may die. In severe cases plants turn black and die	Leaves rolled up at margins, necrosis of rims and death of growing point
Magnesium	Whitish or yellow striping between the leaf veins, followed by necrosis	Older leaves show interveinal reddish-brown mottling	Interveinal chlorosis and puckering of older leaves
Iron	Alternate rows of green and white on leaves	At early stage, patternless paling in leaf colour; later stage, yellowing of leaf similar to N deficiency	Whitish streaks on leaves. Veins unaffected at first, but larger veins eventually turn yellow
Manganese	Yellow and green striping along the length of the leaf	Chlorosis, initially of young leaves, followed by necrotic spots in interveinal areas. Leaves will fall off and plants eventually die	Leaves are of smaller size and exhibit yellow mottling between veins
Zinc	Chlorotic fading of the leaves, with broad whitish areas	Leaves and flower buds are shed	
Copper	Leaves become chlorotic and the tips wither		Leaves chlorotic, heads fail to form, growth stunted
Boron	New leaves show transparent stripes. Growing points die and ears may not develop	Leaves turn yellow and then brown. No flowers or pods are produced	Leaves are distorted, brittle, mottled along margins and wilted
Molybdenum	Not common by itself, but indicators include scorched patches on leaves	Leaves are smaller, pale in colour with interveinal mottling developing into brown scorched areas	Older leaves become mottled, scorched and cupped. Margins are irregular and heart formation is poor
Chlorine	Plants short with poorly-developed stubby roots	Cl essential for the symbiotic fixation of N in legumes. No nodulation and stunted growth	Stunted roots with excessive branching and poor wilted top growth
Copper toxicity	Reduced growth, chlorosis and stunted root development		

3.3. Organic manure

Continuous cropping without any addition or return of fresh or decomposed organic matter will result in a decrease in soil organic matter and a decline in soil structure. The high temperatures in the tropics and subtropics cause a rapid decomposition and mineralization of organic matter. To maintain the humus level of the soil, around 15 tons/ha of organic manure (30% dry matter) are required yearly, depending on the prevailing temperatures. Unfortunately, these amounts are not generally available to smallholders. It is best to reserve the quantities available for fruits and vegetables first, since these crops give the highest return to organic manuring.

There are different types of organic manure (Euroconsult, 1989):

- ❖ **Farmyard manures** are the solid and liquid excreta of livestock, generally mixed with the litter used for their bedding. The composition and quantities vary widely, according to the kind of animal, its feeding and the type of litter used. The annual amount of fresh matter produced by a well-fed adult dairy cow can be 10 tons (30% dry matter). For local cattle kept as draught animals this quantity is in the order of 2-3
- tons, usually with a somewhat higher dry-matter content.
- ❖ **Compost** consists of partially decomposed materials of plant, animal or human origin, alone or in combination. The composting of sufficiently rich manure or waste should lead to temperatures of over 60°C, which will kill disease and pest organisms inside the heap.
- ❖ **Industrial organic manures** mainly consist of by-products of vegetable oil processing and animal products.
- ❖ **Crop residues** are important suppliers of organic matter to the soil. The quantities and composition vary considerably. The growing of local maize varieties, for example, may result in 2-3 tons/ha of straw.
- ❖ **Green manure crops**, mostly *Leguminosae*, produce 20-50 tons of fresh matter, depending on the type of crop, the growing season and the inputs. The dry-matter content is about 15%. Another important factor is the fixation of nitrogen from the air by bacteria. The amount of available nitrogen ranges between 20 and 50 kg N/ha.

Control of pests, diseases and weeds

4.1. Types of pests, diseases and weeds

4.1.1. Pests

Pests are insects, arachnids, rodents and snails that cause damage to a crop to an extent resulting in a noticeable reduction in yield or the total destruction of the crop.

As far as insects are concerned, for practical purposes it is convenient to distinguish between sucking (S) and chewing (C) insect pests (Euroconsult, 1989). Sucking pests are aphids (soft, pear-shaped insects), and white and black flies. Besides inflicting damage by sucking they can also transmit more harmful virus diseases, and their sugary honey dew excretions make affected parts sticky and susceptible to soury fungus growth. Other sucking pests are spider mites, mealy bugs, scales, stainers, stink bugs and thrips (small, elongated and rather fast moving insects with piercing mouths). All sucking pests compete for assimilates, and cause early wilting and shedding of leaves and buds. Chewing pests include seedling, leaf and fruiting point caterpillars (moth larvae or worms), stem and fruit borers, beetles and weevils, grasshoppers, crickets, locusts and some ants that attack seedlings. Nematodes, unsegmented parasitic worms having an elongated, cylindrical body (eelworm, roundworm), are very harmful to crops (see Chapter 2). Some insect pests are shown in Figure 1.

4.1.2. Diseases

A reduction in crop growth may be the result of an insufficient supply of plant minerals or of the activity of toxins produced by bacteria, fungi and viruses. The internal nature of most diseases means that considerable damage is usually done before the symptoms become noticeable, which makes control very difficult (Euroconsult, 1989).

Many bacterial diseases of vegetables are soil-borne. Therefore crop rotation can work preventively. Improvement of the drainage condition of the land can also have favourable effects. Infested plants wilt and die rapidly.

Fungal diseases may appear as blotching on leaves and fruits (for example, downy mildew), as a powdery coating of leaves and fruits (for example, powdery mildew), as the stem or root rots causing wilting and dying, as black rots of veins or stems causing dying, or as lesser leaf spots, moulds,

rusts or wilts. Very serious fungal diseases can appear as Panama disease (*Fusarium* spp.) in banana, as soil-borne stem or root rots (*Phytophthora*) linked with waterlogging in citrus, or with contaminated nurseries in avocado, papaya, and pineapple. Figure 2 shows some examples of fungal diseases.

Viral diseases may be caused by virus infection. They result in loss of vigour, yield and quality, which can be accompanied by rapidly changing colouring.

4.1.3. Weeds

Weeds compete with crops for moisture, nutrients and light, which results in lower crop yields. They are also hosts to a number of pests and diseases. In extreme cases, exudates from the weeds' roots can have a poisonous effect on the crop plant (Euroconsult, 1989). The competition of gramineous weeds is more severe than that of broad-leaved weeds. Crops are most sensitive to weed competition in their early stages of growth. Competition during the first quarter of the growing period can cause irreparable damage to the crop and often results in total crop failures.

4.2. Control measures

There are various methods for controlling pests, diseases and weeds: preventive measures, chemical controls, biological controls, and hand and mechanical controls. Ideally, integrated controls should take place in such a way that all possible measures are used in an environmentally sound and, for the farmer, economically viable programme. This is called integrated pest management and will be explained in greater detail in Chapter 5.

4.2.1. Preventive measures

The most important preventive measures are crop rotation (Chapter 2) and crop hygiene. Crop hygiene includes burning or hot composting of affected material and prompt removal of crop residues, stalks and stumps after harvest. It is also important to obtain seeds from reliable sources, to treat the seed or plant material and to improve seedbed management (Chapter 6). Resistant or tolerant varieties should be used. Planting and drainage methods that prevent waterlogging should be applied. A balanced mineral supply should also be provided.

Figure 1
Examples of insect pests (Source: Purdue University, 1993)

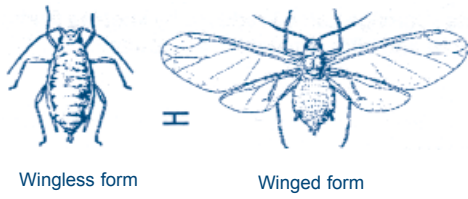

a. Aphids (S)

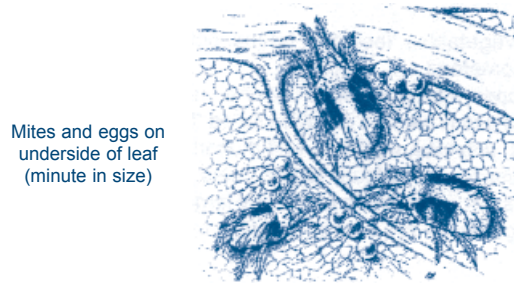

b. Two-spotted spider mite (S)

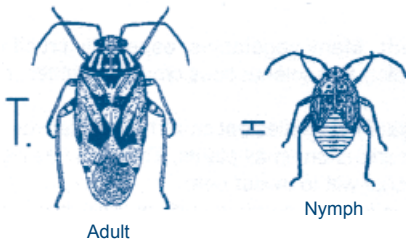

c. Tarnished plant bug (S)

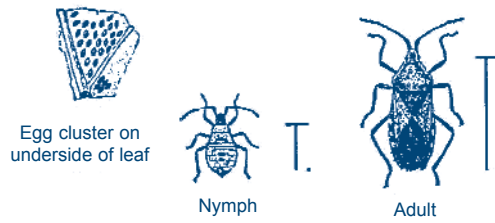

d. Squash bug (S)

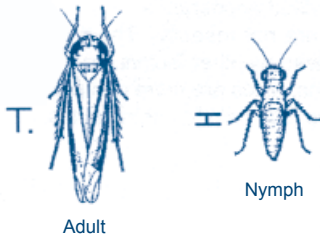

e. Leafhopper (S)



f. Cutworm (C)

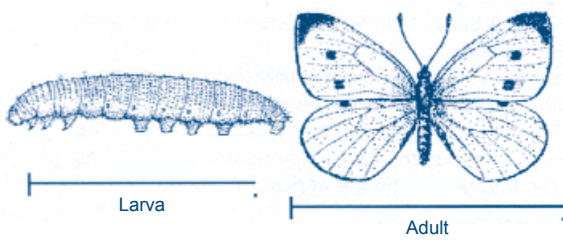

g. Cabbage worm (C)

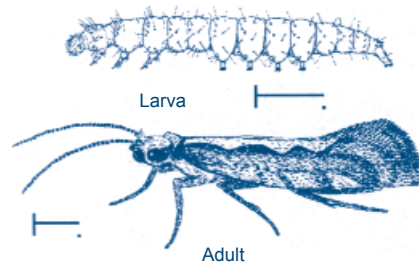

h. Diamondback moth (C)

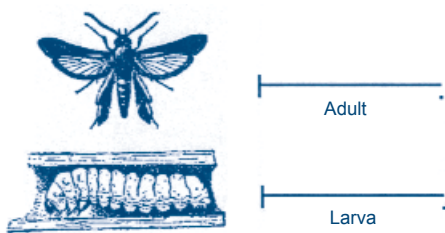

i. Squash vine borer (C)



j. Garden slug (C)

Figure 2
Examples of fungal diseases (Source: Our Garden Gang, 2002)



a. *Fusarium* on tomato leaves



b. *Verticillium* on tomato leaves

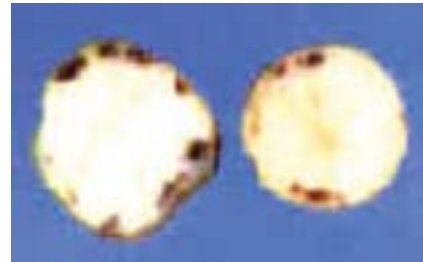

c. *Fusarium* on potatoes



d. *Mildew* on leaf

Preventive measures in weed control are meant to check further spreading of weeds. They include early cultivation and the use of uncontaminated seed, the eradication of weeds before seeding is started, keeping irrigation canals clean, proper composting of manure and the prevention of soil and water runoff (Euroconsult, 1989).

4.2.2. Chemical control

Chemical control refers to the use of chemicals to destroy pests and disease-causing organisms, to control their activity or prevent them from causing damage. Chemicals are often specified by the name of the active substance. However, farmers, extension people and shopkeepers are more familiar with its trade name. The list in Table 9 makes an easy check possible, indicating the trade name, the active substance (the chemical responsible for the desired effect upon a pest), the type of chemical and its general use. The triangle category is an indication of how poisonous the

product is. Too often people seem to be too careless with dangerous products. Therefore, some information on the different categories has been added.

Green pesticides:

- ❖ Formulations with an Acute Oral Lethal Dose of 50% (LD50)¹ of over 2 001 mg per kg of bodyweight.
- ❖ Can be used without danger in the home or where stated as a mixture to grain or other stored produce for human or animal consumption.
- ❖ Can be offered for sale by any shop or store.
- ❖ The label on the packing should show the word 'Caution' within a green triangle and the words 'Harmful if swallowed' beneath the base of the triangle.

Amber pesticides:

- ❖ Formulations with an LD50 of between 501 and 2 000 mg per kg of bodyweight.

¹ LD50: The quantity of an active ingredient taken by mouth or absorbed by the skin, which is expected to kill 50% of the test animals. It is expressed in mg chemical per kg of bodyweight of the test animals. The greater the quantity of pesticide required to reach a LD50, the lower the toxicity of the product.

- ❖ Can be used without danger in home gardens and for external use in the home.
- ❖ Can be offered for sale by a retailer, if a special part of the shop or store has been set aside for the specific purpose of display, storage or sale of dangerous substances.
- ❖ The label on the packing should show the word 'Danger' with a symbol of a skull and crossbones within an amber triangle and the word 'Poison' beneath the base of the triangle.

Red pesticides:

- ❖ Formulations with an LD50 of between 100 and 500 mg per kg of bodyweight.
- ❖ Use should be generally restricted to horticultural, agricultural, health or industrial pest control operations. Only applied in homes by a recognized pest control operator where specific precautions are taken and the insecticide has been registered for a particular purpose.
- ❖ May only be sold by a licensed dealer, where a special part of the premises has been set aside for the specific purpose of display, storage and sale of dangerous substances.
- ❖ The label on the packing should show the word 'Danger' with a skull and crossbones symbol within a red triangle and the words 'Dangerous poison' beneath the base of the triangle.

Purple pesticides:

- ❖ Formulations with an LD50 of up to 100 mg per kg of bodyweight.
- ❖ May only be sold to persons whose business, profession or trade requires them.
- ❖ May only be offered for sale by licensed dealers, where part of the premises is set aside for the sale of dangerous substances. The dealer must keep a poison register of all sales of this group of pesticides, each sale being countersigned by the purchaser or his nominee, and the farm license number must be noted.
- ❖ The label on the packing should show the word 'Danger' with a skull and crossbones symbol within a purple triangle and 'Very dangerous poison' or 'Extremely poisonous' beneath the base of the triangle.

In order to avoid a resistance built-up, different products should be used and alternated, so far as the farmer can afford it.

Depending on the pests and diseases to be controlled, the following pesticides can be used:

Insecticides:	Insects
Molluscicides:	Snails, slugs
Rodenticides:	Mice, rats
Acaricides:	Spiders
Herbicides:	Weeds
Nematicides:	Nematodes
Fungicides:	Fungi
Bactericides:	Bacteria

Pesticides can be classified according their mode of action as follows:

- ❖ Contact pesticide: controls when it comes in contact with the pest; doesn't translocate
- ❖ Stomach pesticide: must be eaten by a pest in order to control the pest
- ❖ Systemic pesticide: is absorbed and translocated within a plant or animal
- ❖ Fumigant: produces a gas, vapour, fume or smoke intended to destroy insects, bacteria and rodents

Pesticides can appear in the following forms:

- ❖ Emulsifiable Concentrate (EC): Liquid formulation in which the active ingredient is dissolved in a petroleum solvent, plus an emulsifier
- ❖ Wettable Powder (WP): A solid powder formulation that when added to water forms a suspension used for spraying
- ❖ Granules (G): Small dry pellets, low concentrate mixtures of pesticides and inert carriers, used as it is
- ❖ Bait (B): Edible material that contains a pesticide and is attractive to the pest
- ❖ Dust (D): Finely-ground mixtures combining a low concentration with an inert carrier (talc, clay, ash)
- ❖ Flowable (F): Finely-ground solid material, which is suspended in a liquid and usually in high concentration, that requires dilution with water
- ❖ Fumigant: Pesticide in the form of gas that can kill when absorbed or inhaled

It should be noted that some chemicals can disappear from the market and be replaced by new ones. The list in Table 9 therefore needs constant updating.

Table 9
List of some chemicals, their active substance and use

Trade name	Triangle category	Active substance	Description	Disease
Insecticides/Acaricides				
Anthio 33 EC	Red	Formothion	Systemic + Contact Insecticide	Aphids, Thrips
Azodrin 40	Purple	Monocrotophos	Systemic Insecticide (organosphate)	Aphids, Tuber Moth, Cutworm, Loopers, Mite
Biobit	Green	Bacillus thuringiensis	Biological Insecticide	Diamondback moth (in Cucurbits)
Carbaflow 50	Amber	Carbaryl	Insecticide	Stalk Borer, Caterpillars, Army Worm, Cutworm, Tuber Moth, Grasshoppers
Carbaryl 85% WP	Red	Carbaryl	Contact + Stomach Insecticide (carbamate)	Caterpillars, Grasshoppers, Army Worm
Chlordasol	Amber	Chlordane	Contact + Stomach Insecticide	Termites
Curaterr 10	Purple	Carbofuran	Granular Insecticide	Stalk Borer
Cymbush 20EC	Red	Cypermethrin	Contact + Stomach Insecticide	Cutworm, Army Worm, Thrips, Heliothis in cotton
Decis	Amber	Deltamethrin	Insecticide	Aphids
Dimethoate EC	Green	Dimethoate	Systemic + Contact Insecticide Acaricide (organosphate)	Aphids
Dimethoate	Red	Dimethoate	Systemic + Contact Insecticide + Acaricide	Alphids
Dipterex 2.5% G	Green	Trichlorfon	Stomach Insecticide (organophosphate)	Maize Stalk Borer
Kelthane EC	Red	Dicofol	Acaricide	Red Spider Mite
Lebaycid	Amber Baytex	Fenthion Baycid,	Stomach + Contact Insecticide	Fruitfly (in Cucurbits)
Malathion 50% WP	Green	Malathion 50%	Contact + Stomach Insecticide + Acaricide (organosphate)	Thrips, Aphids, Red Spider Mite
Metasystox 25% EC	Red	Dimethon-s-methyl	Systemic Insecticide + Acaricide (organophosphate)	Aphids, Red Spider Mite, White Fly
Neoron	Green	Bromopropylate	Acaricide	Mite (in citrus)
Nogos 50 EC	Red	Dichlorvos	Contact Insecticide	White Fly, Aphids, Thrips
Nuvacron 40	Green	Monocrotophos	Insecticide + Acaricide	Aphids, Red Spider Mite, Cutworm, Stalk Borer
Parathion 25	Purple	Parathion	Insecticide	Thrips, Aphids, Borers, Diamondback moth
Patriot 2.5% EC	Green	Deltametrin	Contact + Stomach Insecticide (pyrethroid)	White Fly, Aphids
Pirimor	Red	Pirimicarb	Stomach + Contact Insecticide + Acaricide	Aphids (in cotton, wheat)
Tameron	Purple	Methamidophos	Systemic + Contact Insecticide	Cutworm, Aphids, Tuber moth
Tetradifon, Tedion	Green	Tetradifon	Acaricide	Red Spider Mite (in cotton, citrus, deciduous fruit)
Thiodan 50, Thionex	Purple	Endosulfan	Stomach + Contact Insecticide (cl-hydrocarbon)	Aphids, Thrips, Heliothis bollworm, Diamondback moth
Torque		Fengutanin-oxide	Stomach + Contact Insecticide + Acaricide	Used in citrus, soft fruit, vines, etc.
Fungicides				
Afugan	Amber	Pyrazophos	Fungicide	Powdery Mildew (in Cucurbits)
Antracol 70 WP	Green	Propineb	Fungicide	Blight, Leaf Spot
Bavistin	Green	Carbendazim	Systemic Fungicide (Benzimidazole)	Powdery Mildew, Cercospora, Botrytis, Anthracnose
Baycor	Amber	Bitertanol	Fungicide	Cercospora, Leaf Spot, Phoma in groundnuts
Bayleton		Triadimeton	Fungicide	Powdery Mildew

Trade name	Triangle category	Active substance	Description	Disease
Benomyl	Green	Benlate	Systemic Fungicide	Powdery Mildew, Botrytis, Cercospora, Leaf Spot, Fusarium
Brassicol 75	Green	Quintozene	Fungicide	Damping-off
Bravo 500	Green	Chlorothalonil	Contact Fungicide	Downey Mildew, Blight, Anthracnose, Leaf Spot
Captan 50 WP	Green	Captan	Fungicide	Damping-off, Blight, Leaf Spot
Copper Oxychloride	Red	Copper Oxychloride	Fungicide	Scab, Blight, Leaf Spot, Downey Mildew, Rust
Dithane M45	Green	Mancozeb	Fungicide (Dithiocarbamate)	Rust, Blight, Downey Mildew, Leaf Spot, Anthracnose, Scab, Black Spot
Karathane 25	Green	Dinocap	Fungicide	Powdery Mildew
Kocide		Copric hydroxide	Fungicide	Rust in coffee
Mancozeb 80%	Green	Mancozeb	Fungicide	Rust, Blight, Downey Mildew, Leaf Spot, Anthracnose, Scab, Black Spot
Milraz 76 WP	Amber	Propineb	Systemic & Contact Fungicide	Late blight in potatoes
Morestan 25%	Green	Chinomethionate	Fungicide	Powdery Mildew
Nimrod	Green	Bupirimate	Systemic Fungicide	Powdery Mildew (in roses)
Polyram-DF	Amber	Metiram	Fungicide	Blight, Leaf Spot, Rust, Anthracnose, Damping-off (vegetable seedlings)
Ridomil MZ 72	Amber	Mancozeb	Systemic & Contact Fungicide	Blight, Downey Mildew
Sulphur Cosan	Green	Pure sulphur	Fungicide	Powdery Mildew
Tecto	Green	Thiabendazole	Fungicide	Fusarium, post-harvest treatment
Thiram 80	Red	Thiram	Fungicide (Dithiocarbamate)	Damping-off: Rhizoctonia, Phytiom
Thiram 80 WP	Red	Thiram	Fungicide & Insecticide	Damping-off (beans & brassica)
Zineb		Zineb	Contact Fungicide	Downy Mildew (in Cucurbits)

4.2.3. Biological control

Biological control refers to the process of pest management achieved through the use of living organisms, namely predators, parasitoids or pathogens (Verkerk, 2001).

Predators are organisms that prey on and feed on other organisms. Each predator generally kills several prey during its lifetime. Immature and/or adult stages can be predatory. Some predators feed on a wide range of species (generalists), while others are more specialized in their choice of prey, feeding on only one or a few species (specialists). Examples of predators are: ladybird beetles, ground beetles, mantids, dragonflies, predatory mites, predatory wasps, spiders.

Parasitoids are organisms that during their immature (larval) stages feed on and eventually kill a single arthropod, and in their adult stage are with a very few exceptions free-living. About 8.5% of insect species described to date (approximately 85 000 species) are parasitoids. They are nearly all wasps or flies, but include a relatively small number of beetles and very occasionally other groups. The adults of most agriculturally important parasitoid species feed on sugary substances such as the nectar of flowers or aphid honeydew. The larvae may feed from within or outside the body of their host. Many species are regarded as

solitary with only one parasitoid developing per host, or they may be gregarious with many larvae (sometimes hundreds) developing per host. Most parasitoids are highly or relatively specific (specialists), selecting only a single host species or narrow range of species as targets. Examples of parasitoids are: parasitoid wasps and flies.

Pathogens are disease organisms. They can be important in controlling the growth of pest populations in agricultural systems. They include fungi, bacteria, viruses, nematode worms and microsporidia. Many pathogens tend to be found more commonly where pest populations are large or during the rainy season. Examples of pathogens are: *Metarhizium*, *Zoophthora*, *Entomophthora* (entomopathogenic fungi), GV (granulosis virus), NPV (nuclear polyhedrosis virus), *Bacillus thuringiensis* (bacterium), EPNs (entomopathogenic nematodes).

For more information on the application of biological controls, the reader is referred to literature specialized in the subject, such as the field guide prepared by Verkerk (2001).

4.2.4. Hand and mechanical weeding

Methods that can be used for weed control, other than preventive measures and chemical and biological control, are hand or mechanical weeding.

Integrated production and pest management (IPPM)

The protection of plants by combatting the negative effects of pests and diseases on crop production is of major importance for food security in developing countries. This is particularly true for regions where increased productivity and production is needed to reach the goal of food security. However, the aim of plant protection is not to ensure maximum production but to ensure optimum production in an economical and sustainable sense (IAC, 2000).

Pesticides, as described in the previous chapter, form an important means to control pests and diseases. However, despite their widespread use, pest damage still causes significant yield loss in agricultural systems. According to FAO, pre-harvest crop losses caused by pests and diseases are in the order of 30-35% worldwide. With the rapid growth of pesticide resistance in insects, pathogens and weeds, these losses are likely to increase. Thus, it is important to integrate various control measures and not rely on chemical controls alone. A judicious use of pesticides is moreover justified by the increasing awareness of the environment, the need to implement sustainable agricultural production methods and the occurrence of accidents with pesticides.

A range of techniques that may be used by farmers is already available. These include the use of various cultural practices such as crop rotation (Chapter 2), multiple cropping, timing of planting, further habitat management that enhances natural enemy populations, biological control agents, direct trapping of insects, use of thresholds and, finally, the careful and timed use of pesticides. The whole concept, utilizing all possible pest control measures in an environmentally sound and, for the farmer, economically viable programme, is called Integrated Pest Management (IPM).

5.1. Description of IPM and IPPM

There are many descriptions and definitions for the term IPM. The FAO Global IPM Facility prefers to describe IPM by four principles that it considers key to most IPM programmes:

- ❖ Grow a healthy soil and crop
- ❖ Conserve natural enemies
- ❖ Observe the field regularly
- ❖ Farmers become experts

As IPM programmes developed, the role of good soil husbandry and production practices for crop yields and plant protection became better understood. For example, antagonist pathogens need organic matter, an improper nitrogen balance will result in some disease, and pest problems and micro-nutrient deficiencies are often confused with disease or insect problems. A new term was introduced by the Zimbabwean programme, which both expressed the need to emphasize production aspects and to provide ownership to a wide group of experts: Integrated Production and Pest Management (IPPM). The term IPPM is now used in many national and local programmes in the East and Southern Africa sub-region (FAO, 2000a).

All IPM programmes share the same components (University of Wisconsin, 2000):

- ❖ Monitoring the pest population and other relevant factors
- ❖ Accurate identification of the pest
- ❖ Determining injury levels and thresholds that trigger treatments
- ❖ Timing treatments to the best advantage
- ❖ Spot-treating for the pest
- ❖ Selecting the least disruptive tactics
- ❖ Evaluating the effectiveness of treatments to fine-tune future actions
- ❖ Educating all people involved with the pest problem

IPM requires continuous assessment of a situation. There are four key questions that must be answered before implementing any management strategy (University of Wisconsin, 2000):

- ❖ **Is treatment necessary?** The mere presence of a pest doesn't necessarily warrant treatment. Sometimes a fairly large population of pests can be tolerated while at other times the presence of a single pest is intolerable. In addition, the determination of treatment will vary among individuals.
- ❖ **Where should the treatment take place?** Pest managers must look at the whole system to determine the best place to solve the problem. Apply treatments where the actions will have the greatest effect. In order to do this the biology and behavior of the pest at hand must be completely understood.

- ❖ **When should action be taken?** Timing is very important. There are optimum times in both insect and disease life cycles when they are most susceptible to control. Again, it is very important to understand the biology and behavior of the pest.
- ❖ **Which strategies should be used?** IPM uses a multi-tactic approach. Because biological systems are complex, management strategies must also integrate several tactics. Rarely will a single tactic solve the problem for long. Implementing an IPM programme means taking a 'whole system' or ecosystem approach to solve a pest problem. Both the living and non-living components should be taken into consideration when determining which approach to take as each component has an impact on every other component.

There are four control strategies that can be used in developing an IPM programme (University of Wisconsin, 2000):

- ❖ **Cultural** control uses fertilization, irrigation, site selection, plant selection and/or sanitation to prevent pest problems in the first place
- ❖ **Physical/mechanical** control is another preventative strategy. It includes screens or other barriers, temperature and humidity modification, traps, physical repellents, and hand removal of weeds.
- ❖ **Biological** control uses beneficial organisms (insects, bacteria, etc.) to control pests. IPM programmes seek to conserve naturally-occurring beneficial insects by providing them with food and shelter and not using broad-spectrum insecticides that will inadvertently kill the beneficial insects.
- ❖ **Chemical** control is used only after all other suitable control strategies have not been fully effective or practical. Always use chemicals in an environmentally responsible manner and in accordance with the label.

According to FAO's Global IPM Facility, experience has shown that:

- ❖ IPM is about people: to succeed it has to be a farmer-driven process.
- ❖ IPM increases the sustainability of farming systems. It improves ecological sustainability, as it relies primarily on environmentally benign processes, including the use of pest resistant varieties, the actions of natural enemies and cultural control. It improves social stability because it is institutionalized at the level of the farming community and local government. Finally, IPM programmes are economically sustainable as they reduce farmers' dependence on procured inputs.
- ❖ IPM addresses far more than purely pest management. It offers an entry point to improve the farming system as a whole.

- ❖ The Farmers' Field School concept can be used to address other farming situations and extension problems.

5.2. Farmers' Field School (FFS)

The Farmers' Field School (FFS) is a learning process for groups of farmers during which they discover the ecological relationship between pests, natural enemies and other factors affecting the health of their crop, thus enabling them to make more efficient and healthier crop management decisions. The basics are (Toxic Trial, undated):

- ❖ FFS is field-based and lasts for a full cropping season
- ❖ FFS educational methods are experiential, participatory, and learner-centred
- ❖ Each FFS includes at least three activities: the agro-ecosystem analysis, a 'special topic', and a group dynamics activity
- ❖ In every FFS participants conduct a study comparing IPM with non-IPM treated plots
- ❖ Between 25 and 30 farmers participate in a FFS; participants learn together in small groups of five to maximize participation
- ❖ Preparation meetings precede a FFS to determine local needs, and concluding meetings organize 'follow-up' activities

Farmers trained in Community IPM grow healthier crops and minimize constraints, such as those imposed by pests, through a better understanding of how their management decisions affect the ecology of their fields. Armed with this knowledge, IPM farmers become better managers and:

- ❖ Reduce their dependence on agro-chemicals
- ❖ Reduce costs of production and increase their incomes
- ❖ Stabilize their yields
- ❖ Safeguard their health
- ❖ Protect the environment

FFS uses adult non-formal education methods including field studies and structured hands-on experiential learning activities. Examples of these studies include comparison trials between conventional methods and IPPM methods, varietal monitoring and minimum tillage studies. Learning activities are concept specific and include activities such as disease, insect, natural enemy lifecycles, soil profiling and crop dissection (FAO, 2000b).

To learn more about IPPM, the reader is referred to more specialized literature in the subject, which can be found through the website of the FAO Global IPM Facility:

<http://www.fao.org/waicent/faoinfo/agricult/aggp/aggpp/ipm/>

Chapter 6

Raising vegetable seedlings

The major factor in ensuring an optimum plant population is the quality of the vegetable seedlings, raised in situ or through transplanting techniques. Seed prices are rising and thus more care has to be exercised to ensure the optimum use of these expensive inputs.

Traditional methods of raising seedlings have several disadvantages. The greatest disadvantage is the inability to achieve optimum environmental growing conditions by controlling such factors as soil temperature, moisture status, soil structure and disease control.

Improved methods of raising seedlings, like protected cultivation (see Section 6.5), require a higher level of skill from the grower and an increase in capital investment. It is not, however, necessary to use very expensive structures and complicated heating/cooling systems, since appropriate cheap, locally available constructed substitutes can be used. But there is no substitute for the attention to detail required in the day to day management and care of the plants, which is essential to the production of a vigorous uniform product. The advantages of improved vegetable seedling production systems include:

- ❖ Higher rates of seed germination, especially when using expensive hybrid seeds
- ❖ Lower incidence of pests and diseases

- ❖ Greater control over seedling densities in the nursery, allowing optional spacing, which helps to produce stronger plants with earlier and higher yields
- ❖ Improved continuity planning, allowing the farmer to harvest when market prices are high or making the farmer less dependent on market prices
- ❖ Shorter interval from planting to first harvest in the field
- ❖ Easier weed control of transplanted crops
- ❖ Improved protection against pests and diseases during the early stages of propagation
- ❖ Possibility pre-treating of the soil and seedlings prior to planting, which is cost-effective

6.1. Seed storage

After harvest, seeds are usually stored for varying lengths of time. The viability of the seeds at the end of storage is dependent on the initial viability after harvest and the rate at which deterioration takes place. The rate of deterioration depends on the crop type and the storage conditions, the most important being temperature, humidity and the moisture content of the seed itself. High moisture content and high temperatures will result in the fast decline of seed viability. Lower temperatures prolong the viable period of

Table 10

Maximum moisture content of seeds to enable one year storage at different storage temperatures, as recommended by USDA (Source: FAO, 1999)

Species	Recommended maximum moisture content (%)		
	at 4-10°C	at 21°C	at 27°C
Bean	15	11	8
Cabbage	9	7	5
Cauliflower	9	7	5
Broccoli	9	7	5
Carrot	13	9	7
Celery	13	9	7
Cucumber	11	9	8
Lettuce	10	7	5
Okra	14	12	10
Onion	11	8	6
Capsicum	10	9	7
Tomato	13	11	9
Water Melon	10	8	7

seeds and can be used to reduce the effects of high moisture content. Going from 45°C to 0°C, each decrease of 5°C will double seed storage life (FAO, 1999). Table 10 shows the maximum safe moisture contents of seeds for a storage period of one year at different temperatures. Table 11 shows the viability periods of seeds, if stored under the conditions recommended in Table 10.

Table 11
Expected viability periods of seeds of various vegetables when stored under the conditions recommended in Table 10, according to the University of California (Source: FAO, 1999)

Viability of seeds (years)	Vegetable
1	Onion, parsley
2	Capsicum, leek, okra
3	Asparagus, bean, broccoli, carrot, celery, chinese cabbage, pea, spinach
4	Eggplant, brussels sprout, cabbage, cauliflower, red beet, tomato, watermelon
5	Cress, cucumber, radish
6	Lettuce

Table 12
Hot water treatment of seed for disease control (Source: FAO, 1999)

Vegetable	Temperature (°C)	Time (minutes)	Disease controlled
Broccoli	50	20	Alternaria, Blackleg, Phoma
Cauliflower	50	20	Alternaria, Blackleg, Phoma
Eggplant	50	25	Phomospsis Blight, Anthracnose
Capsicum	50	25	Bacterial Leaf Spot, Rhizocotonia
Tomato	50	25	Anthracnose, Canker

Table 13
Germination temperatures, time to germination and time required to produce a field viable transplant (Source: FAO, 1999)

Crop	Minimum temperature (°C)	Optimum germination temperature (°C)	Time to germination under optimum temperature (days)	Time required to produce a field viable transplant under optimum conditions (days)
Broccoli	-	29.5	4	35 - 50
Cabbage	-	29.5	4	35 - 50
Cauliflower	1.3	26.5	5	35 - 50
Cucumber	12.1	32.0	3	15 - 20
Eggplant	12.1	29.5	5	35 - 50
Lettuce	3.5	24.0	2	28 - 30
Onion	1.4	24.0	4	70 - 85
Pepper	10.9	29.5	8	35 - 50
Squash	-	32.0	3	20 - 30
Tomato	8.7	29.5	5	35 - 50
Watermelon	12.2	32.0	3	20 - 30

6.2. Seed treatment

Seed treatment is used to eliminate seed-borne pests or diseases and to prevent early infections in the seedbed. There are two broad categories of seed treatment: hot water treatment and treatment by use of chemicals.

Hot water treatment of seed requires critical control of water temperature for a precise period of time (Table 12).

As far as chemical treatment is concerned, the most widely used fungicides for seed treatment are Thiram, Captan and Benomyl applied as a dust or slurry.

6.3. Germination and emergence

Seed germination and emergence are affected by seed quality and seedbed environment (moisture status, temperature, and osmotic potential). Too low temperatures slow down the physiological process associated with germination and can reduce germination percentages and uniformity. In severe cases, too low temperatures can prevent the seedling from emerging out of the soil. Too high temperatures can induce dormancy.

For best results, the environmental conditions should be controlled as carefully as possible after sowing to ensure as rapid an emergence of the seedling as possible. When tray production systems are used (Section 6.4.10), they can be placed into carefully-controlled environmental chambers or germination rooms, where possible, in order to reduce the fluctuations in temperature and moisture that occur in open air or even under protected cultivation structures (Section 6.4.9). Temperature is generally maintained at 15-25°C with a relative humidity in excess of 90% (FAO, 1999). Trays are left in the germination room until the emergence of the radicle. This takes a different length of time for each vegetable species. Table 13 shows the optimum germination temperatures, the number of days to germination under optimum temperature and the time required to produce a field viable transplant under optimum conditions.

6.4. Improved seedbed management

Field-grown seedlings are almost always inferior to seedlings produced under protected cultivation or seedlings raised in module systems. However, the quality of field-grown seedlings can be improved through improved seedbed management, including the use of simple techniques as described below.

6.4.1. Rotation

It is important that the seedbed is moved each year to a site that has not grown the same species or vegetable group in the previous 4 years, or even longer if nematodes are known

Table 14
Vegetable grouping for rotational purposes

Group	Examples
Allium crops	Onion, garlic, leek, shallot
Brassicac	Cabbage, rape, kale
Grasses	Grain crops, maize, sweet corn, baby corn, wheat
Legumes	Pea, bean, cowpea
Roots	Carrot, sweet potato
Solanaceous crops	Potato, tomato, pepper, paprika

Table 15
Temperatures required to destroy pests in soil (Source: Maynard and Hochmuth, 1997)

Pest	Temperature to be maintained for 30 minutes (°C)
Nematodes	50
Damping-off fungi (cause sudden death of seedling)	55
Most pathogenic bacteria and fungi	65
Soil insects and most viruses	70
Most weed seeds	80
Resistant weeds and viruses	100

to be present. A standard crop grouping for general rotation purposes is presented in Table 14.

6.4.2. Soil sterilization

Numerous techniques are available for soil sterilization or, more correctly, pasteurization, of which the following three can be mentioned:

Steaming of the soil

Heating of the seedbed soil, for example in a drum cut in half longitudinally, is a cheap method that will help the farmer in limiting the effect of soil-borne diseases. Steam can be used to heat the soil to temperatures in excess of 80°C for 30 minutes or more, as required for disinfestation (Table 15). Practice will determine the time needed to get the soil to the required temperature and keep it like that for 30 minutes. However, this is not a common practice for seedbed soil sterilization in the sub-region. It is a technique mainly used in greenhouses.

Soil solarization

Solarization works in the same way as a greenhouse, where a transparent covering, in this case 3 or 6 mm plastic sheeting, traps the sun’s heat. After several days of sunshine, soil temperatures rise to as high as 55-60°C at the surface and over 40°C as far down as 25 cm. It takes four to six weeks of sunny weather to pasteurize the soil. The following steps need to be taken:

- ❖ Prepare the soil: pull any weeds or old crops; turn in any soil amendments and then rake the surface smooth; remove any stones or clumps that might raise the plastic and create air pockets that could cause uneven heating
- ❖ Water thoroughly to create 100% humidity under the plastic, which acts with the heat to kill all unwanted critters
- ❖ Dig a trench all around the bed or plot 15-20 cm deep

- ❖ Lay a clear plastic sheet 3-6 mm thick over the area, overlapping the trench on all sides. Fill in the trench with soil, weighing down the plastic while pulling it as tight as possible.

Although cloudy weather will slow things down by cooling the soil under the plastic, a few weeks of sunshine will improve the soil dramatically, easily and inexpensively. In cooler or cloudy areas, adding a second sheet of plastic can speed up the process. Using the hoops commonly used to elevate row covers or bird netting, raise the second sheet of plastic over the ground-level sheet. The airspace between acts as a temperature buffer zone during cloudy weather and the combination of the two sheets of plastic serves to raise the soil temperature by an additional 4°C.

Use of chemicals

A granular formulation of chemicals, such as Dozamet and Nemaquir, provides effective control of nematodes, soil fungi, pests and weeds.

6.4.3. Seedbed preparation

The area designated for the seedbeds should be a level piece of land that is cleared of all weeds and easily accessible, with good drainage possibilities. The seedbed should be lifted, with drains on the side. A convenient size of a seedbed is 10 m by 1 m.

A good seedbed should have a good loose physical structure, with a fine enough tilth to ensure close contact between the seed and the soil so that moisture can be readily supplied to the seed. Sufficient organic matter should be well incorporated during primary cultivation to improve soil structure and promote good root development. Sufficient time should pass before sowing to allow for decomposition of the organic matter and the elimination of any phytotoxic gasses such as ammonia. Soil pH should be adjusted to the specifics for each crop and a base fertilization with a general fertilizer (N-P-K) carried out prior to sowing.

6.4.4. Sowing the seeds

Sowing the seeds in rows is far better than broadcasting the seeds over the bed. The distance between rows should not be less than 15 cm in order to be able to use a hoe. Within the row, the aim is to space the seeds no closer than 2.5 cm. The depth of sowing is critical and should be between 1.25 cm and 1.5 cm for brassicas, onions and tomatoes. For other species, the sowing depth depends on the seed size (the depth should be 0.5 to 3 times the seed diameter), the season (the drier, the deeper the sowing depth), the soil or substrate (the lighter the soil or substrate, the deeper the sowing depth).

6.4.5. Thinning the seedlings

If after emergence the seedlings are too closely spaced, the surplus seedlings should be removed by hand.

6.4.6. Weed, pest and disease control

Post-emergence management is critical to ensuring production of healthy plants. Weeds should be removed and a routine pest and disease control should take place.

6.4.7. Irrigation

After sowing by hand and covering the seeds with soil, the seedbed is lightly firmed and watered. A plastic sheet or organic mulch can be spread over the bed, depending on prevailing climatic conditions. These must be removed immediately after the seedlings emerge.

Irrigation should be carefully undertaken. Over-watering is a common mistake and may result in damping-off (sudden death of the seedling caused by fungi) by *Rhizoctonia*, *Phytophthora* or *Fusarium* species.

Stopping the irrigation several days to one week before transplanting is recommended to harden off the seedlings. The seedbed should be watered prior to transplanting in order to facilitate the removal of the seedling from the bed.

6.4.8. Transplanting

To minimize transplant shock the following should be done:

- ❖ Harden off the plants from several days to one week prior to transplanting by reducing watering to slow down the growth process and allow the young plant build up carbohydrate reserves
- ❖ Water the seedbed prior to transplanting (the night before lifting) to facilitate the removal of the seedling from the bed
- ❖ Lift the seedlings at the proper stage of development (as indicated in the description of the different crops in the next chapters)
- ❖ If possible, carry out the operation when rainfall is imminent or under overcast or cloudy conditions
- ❖ Lift the seedlings, using a digging fork, either early in the morning or alternatively in the evening after the worst heat of the day has passed
- ❖ Place the uprooted seedlings and soil in trays with as much root and soil as possible
- ❖ Immediately cover the seedlings with a damp sack, and prevent exposure to full sun or drying winds; under arid conditions frequently rewet the covering
- ❖ Transport the seedlings to a shaded area

- ❖ Plant the seedlings as soon as possible after lifting, preferably in the evening after the worst heat of the day is over, and irrigate immediately

6.4.9. Protected cultivation

A variety of protected cultivation systems are used worldwide to raise seedlings. The most important ones are:

- ❖ Low level polyethylene tunnels
- ❖ Frames
- ❖ Walk-in tunnels
- ❖ Multi-span plastic greenhouses
- ❖ Glasshouses
- ❖ Shade houses

Of these, the most suitable for the smallholder farmers are low level polyethylene tunnels, frames and shade houses.

6.4.10. Module propagation

Vegetable seedlings are increasingly being raised in modular transplant systems, where each seedling is produced in a discrete cell. The individual root systems are kept separate and the aerial portion of the seedlings is given enough space to develop optimally up to the time of transplanting. The cells are joined together in trays containing 40-400 individual cells, called modules or modular trays. The division of the tray into cells means that each seedling is in a separate unit, each with its own compost and requiring its own water and fertilizer.

Compared to bare root raised plants, the benefits of plants raised in the modular systems are significant:

- ❖ The transplanting shock associated with bare root plants is reduced and eliminated if transplanting is carried out before etiolation (the response of a plant to insufficient light, for example due to too high plant density, to which plants react by growing long internodes and reducing chlorophyll from the tissues, making them weaker)
- ❖ Module transplants establish rapidly and withstand adverse conditions better, even drought, resulting in a shortened period to harvest
- ❖ Transplant losses can be dramatically reduced, leading to 10-20% yield increases
- ❖ The full germination capacity of the seed is obtained, therefore the quantity of seeds required per hectare is reduced
- ❖ Crops are more uniform
- ❖ Seedling diseases can be significantly reduced, if not eliminated, by pre-planting drenching by fungicides
- ❖ Seedlings can be treated prior to planting with low-cost residual insecticides, thereby eliminating costly post-planting treatments and thus reducing the chemical costs per hectare
- ❖ Continuity planning is more efficient
- ❖ A specialist plant raiser can supply plants to a large number of farmers
- ❖ Plants can withstand longer transport duration if properly packed

The only disadvantages are that the modular transplant system requires high quality seed and some initial capital input.

Chapter 7

Agronomic aspects of vegetable crops

In the sections below the agronomic aspects of the most important vegetable crops in the sub-region are given. The information refers to the climatic conditions prevailing in Zimbabwe (Chapter 1) and should be adapted for other countries, if the conditions are different. For information on crop water and irrigation requirements, the reader is referred to Module 4. Below, the names and quantities of chemical fertilizers for fertilization are given. As explained

in Chapter 3, wherever possible organic fertilizer should be added. Chemical products for treatment of pests and diseases are also given below. It should be noted, however, that different control methods are possible, as explained in Chapter 4. Integrated Production and Pest Management (IPPM) is becoming more and more successful in the sub-region and its application is highly recommended wherever possible (Chapter 5).

7.1. Baby corn

Scientific name:	<i>Zea mays</i>
Family:	<i>Graminae</i>
Cultivars:	ZS 206, a late yellow dent hybrid, is a suitable local variety in Zimbabwe. Improved multi-cobbing varieties are Pacific No. 5 and Pacific No. 421
Soil:	Best in sandy loam to clay loam soil with a pH 5.3-6.5
Climate:	In the Highveld, baby corn is best produced between September and February and in the Lowveld throughout winter
Seed amount:	30-40 kg/ha
Spacing:	70-90 cm between the rows and 10-25 cm within the row to get 110 000-130 000 plants/ha. Per station 3-4 seeds should be put and thinned to 2-3 plants at 2 weeks
Planting time:	Highveld: September to February. Lowveld: May to August
Growth period:	About 3 months
Fertilizers:	<i>Basal application:</i> 300-450 kg/ha of Compound D <i>Top dressing:</i> 200 kg/ha of AN split twice, at 3 weeks and at 7 weeks
Harvesting:	De-tassel at 45 days from emergence, harvest 1 week after de-tasselling. It is important to harvest at the right stage as the cob develops fast. Harvest cobs when 1 cm of silk is showing, when the cobs are 1-1.5 cm thick and 7-12 cm long. Harvest daily for a period lasting 14-21 days
Expected yield:	700-1100 kg/ha
Pests:	<ul style="list-style-type: none"> • Stalk Borer: <i>Symptoms:</i> Holes in the stalks of baby corn from the inside; stalks fall over and do not produce cobs <i>Control:</i> Apply a few granules of Dipterex 2.5% or Thiodan 1% G to the funnels • Cutworm: Attacks on newly emerged plants at ground level <i>Symptoms:</i> The plants fall and eventually die <i>Control:</i> Spray Dipterex 95% or use Thiodan 50% G • Army Worm: <i>Symptoms:</i> Leaves show signs of being eaten <i>Control:</i> Spray Carbaryl 85% WP at 25 g/10 litres of water • Leafhopper: Vector of maize streak virus <i>Symptoms:</i> yellow streak lines on leaves <i>Control:</i> Cultural methods (use of appropriate rotation, which excludes the continuous use of gramineae)
Diseases:	<ul style="list-style-type: none"> • Rust: <i>Symptoms:</i> Presence of fine red dust on leaves, raised reddish-brown pustules appear on both sides of leaves <i>Control:</i> Grow resistant cultivars • Leaf Blight: <i>Symptoms:</i> Fairly large necrosis marks, which turn chestnut and dark grey <i>Control:</i> Grow resistant varieties • Maize Streak Virus: Viral disease, transmitted to maize by leafhoppers <i>Symptoms:</i> Light green, yellow streaks on the leaves. These may be continuous or mottled <i>Control:</i> Control the vector leafhopper and use resistant varieties

7.2. Bean (green, fine or string)

Scientific name:	<i>Phaseolus vulgaris</i>	
Family:	<i>Leguminosae</i>	
Cultivars:	Several varieties are available, but the most common is Contender	
Soil:	Beans can be successfully grown on a wide range of soil types from light sands to heavy clays, provided they are fertile and well drained. Best yields are obtained on sandy clay loam. Avoid waterlogging soils. The optimum pH range is 5-5.5. Apply lime when soil pH drops to below 5	
Climate:	Beans are warm season crops and are severely damaged by the lightest frost. For good growth and quality pods, the optimum daily temperatures should be between 16-21°C. Temperatures above 35°C cause flower and pod drop, especially when accompanied by desiccating winds. Night temperatures below 5°C during pod formation cause hollow or partially-filled pods. If temperatures fall when crop is near maturity, the pods may become shot and sickle shaped. Flower and pod drop can be experienced if the soils become waterlogged during excessively rainy weather. The crop is susceptible to diseases during prolonged rains with high humidity and high temperatures. A relative humidity of less than 50% is required for good pod setting. Dry, cool conditions are best for harvesting. Seed germination is best when soil temperatures are between 25 and 30°C. Below 15°C germination is poor and above 35°C germination is inhibited	
Seed amount:	800-1000 kg/ha	
Planting depth:	1-2.5 cm	
Spacing:	Double rows 30 cm apart with 75 cm apart between double rows and 40-60 cm between rows. On 90 cm beds, plant three rows spaced 30 cm apart. Space between plants is 5 cm	
Planting time:	Beans cannot stand any frost, while high temperatures will affect flowering and pod setting. In the Lowveld planting takes place between March and May. In the Middleveld planting takes place between September and March. In the Highveld planting takes place between end September and end November as well as the end of February	
Growth period:	2-4 months (including harvest)	
Fertilizers:	<p><i>Basal application:</i> 500-600 kg/ha of Compound S or Compound D</p> <p><i>Top dressing:</i> Beans can fix N (Nitrogen) naturally and too much N fertilizer will promote vegetative growth only. Depending on the state of the crop, there may be need for a shot of Ammonium Nitrate at the rate of 100 kg/ha to start off the growth. One application of 100 kg/ha after flowering could also be necessary</p>	
Harvesting:	Green beans should be harvested when the pods are still immature, when the seeds are small with low fibre content. Harvesting should be done 8 weeks after planting, almost every day. Picking can last 3 weeks. Pack the beans into clean plastic containers or use plasti- lined baskets, keep in a shade and cover with moist sacks	
Expected yield:	8-10 tons/ha	
Pests:	<ul style="list-style-type: none"> • Bean Stem Maggot (BSM) (Beanfly): • Aphids: • Caterpillars: • Red Spider Mite: 	<p>Generally regarded as the principal insect pest of beans throughout Africa. It attacks also other crops, including cowpea and soybean</p> <p><i>Symptoms:</i> The leaves of damaged plants show mining tracks where the maggots feed. The lower parts of the stems become dry, swollen and cracked. Attack by this pest often causes death of young bean plants. Damage by the BSM is more serious in dry areas where yield losses can be as high as 50 to 100%</p> <p><i>Control:</i> Improved management practices. Improve fertility, which leads to vigorously growing plants that are able to tolerate BSM infestation and damage better. Seed dressing with various insecticides, such as Thiodan 50WP, at 5 grams/kg of seed at least during the seedling (and most susceptible) stage. Foliar application of some botanical insecticides, including neem seed extracts, during the early seedling stages. Mulching with cut weeds or straw and earthing up soil in ridges or mounds around the base of the plant, which promotes root establishment</p> <p><i>Symptoms:</i> Affected leaves. They wrap or curl inwards around clusters of aphids</p> <p><i>Control:</i> Use Metasystox 25 EC, at 10 ml/10 litres of water, when seen on a number of plants</p> <p><i>Symptoms:</i> They eat holes in the leaves at night and are dangerous in initial stage</p> <p><i>Control:</i> Use Carbaryl 85% WP, at 20 g/10 litres of water, when holes have been observed</p> <p><i>Symptoms:</i> Small webs at the undersides of the leaves, sucking sap, making the leaves dry and curl</p> <p><i>Control:</i> use Metasystox 25 EC, at 10 ml/10 litres of water, on the underside of leaves when first seen</p>
Diseases:	<ul style="list-style-type: none"> • Bacterial Blight: 	<p><i>Symptoms:</i> Yellow haloes on leaves and pods</p> <p><i>Control:</i> Use resistant varieties as well as Copper Oxychloride 85% WP, at 40 g/10 litres of water, to suppress when symptoms appear</p>

- Bact. pustule of leaves *Symptoms:* Water-soaked spots on pods
Control: Use resistant varieties and apply Copper Oxychloride 85% WP, 40 g/10 litres of (*Xanthomonas* sp.): water, to suppress when symptoms appear
- Anthracnose: *Symptoms:* Sunken, dry spots on leaves and pods
Control: Use Dithane M45, at 30 g/10 litres of water, every 10 days when the first signs of attack have been noticed
- Scab: *Symptoms:* Malformations on pods
Control: Use Dithane M45, at 30 g/10 litres of water, every 10 days when symptoms appear
- Angular Leaf Spot: *Symptoms:* Spots on pods but not water-soaked
Control: Suppress with Dithane M45, at 30 g/10 litres of water, every 10 days when symptoms appear
- Rust: *Symptoms:* Brown pustules on leaves
Control: Use Dithane M45, at 30 g/10 litres of water, every 10 days on the first signs of infection

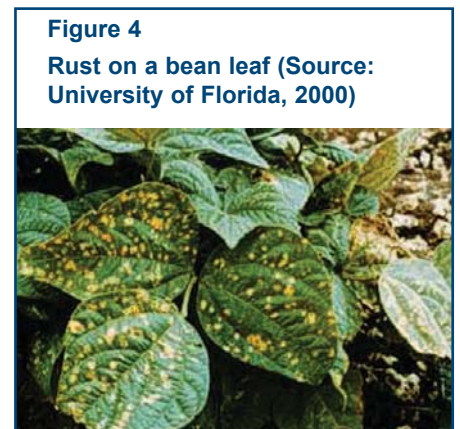

7.3. Cabbage

- Scientific name: *Brassica oleracea* var. *capitata*
- Family: *Brassicaceae* or *Cruciferae*
- Cultivars: Sugarloaf, Drumhead (flat), Cape spitskool. Also consult the seed retailers
- Soil: Cabbages will grow in most well-drained soils that are high in organic matter. Optimum pH 5.5-6.1. When pH falls below 5.5, lime should be applied a month before planting
- Climate: Cabbage can be grown throughout the year, with the exception of some areas. Cool, moist weather conditions produce the best crops. Mature plants can tolerate temperatures of -3°C, but prolonged low temperatures in the range -1-4°C will induce bolting resulting in seed production. The optimum temperature is 18°C, with a maximum of 24°C and an average minimum of 4.5°C. Very wet conditions followed by dry periods results in head bursting. Under warm summer conditions the plants are more susceptible to aphid infestation and cabbage diamondback moth. Both pests require routine control. Bacterial black rot is common in summer
- Seed amount: 450 g/ha
- Seedbeds: 5 beds of 10 m x 1 m each will cater for 1 ha
Mix 60 grams of Compound D or Compound S per m² into the seedbed soil
- Transplanting: After 4-6 weeks, during the cooler period of the day
- Spacing: 45-60 cm between the rows and 30-45 within the row, giving 49300-74000 plants/ha
- Planting time: Highveld: February to August; best in winter, since cabbages can stand short periods of frost. Summer cabbage needs intensive disease control. Lowveld: May to July (winter)
- Growth period: Seedbed: 4-6 weeks. In the field: 4-5 months
- Fertilizers: *Basal application:* 600-1000 kg/ha of Compound D or Compound S
Top dressing: 3 x 100 kg/ha of AN, after every 3 weeks, starting with the first one 3 weeks after transplanting
- Harvesting: Harvesting is done by selecting those heads that are firm, although hybrid cultivars will be ready almost at the same time
- Expected yield: > 25 tons/ha, depending on the cultivar

Pests:	<ul style="list-style-type: none"> • Aphids: <i>Symptoms:</i> Poorly-developing leaves, curling inside covering a clusters of aphids <i>Control:</i> Use Dimethoate 40 EC, at 10 ml/10 litres of water, when the insects have been observed on a few plants • Spider Mite: <i>Symptoms:</i> Little red mites, mostly on the underside of the leaves forming small webs, making leaves dry and stem curly in later stage <i>Control:</i> Use Nuvacron 40, at 50 ml/10 litres of water, when first signs are detected • Diamondback Moth: <i>Symptoms:</i> Small green caterpillars are observed often covered in a web, eating leaves <i>Control:</i> Use Carbaryl 85% WP, at 20 g/10 litres of water 	<div style="border: 1px solid black; padding: 5px; margin-bottom: 5px;"> <p>Figure 5 Aphid colonies on a cabbage leaf (Source: Levêthe et al., undated)</p> </div> 
Diseases:	<ul style="list-style-type: none"> • Damping Off: <i>Symptoms:</i> Bottom of seedling is pinched, followed by wilting. Can be caused by <i>Rhizoctonia</i>, <i>Pythium</i>, <i>Phytophthora</i> and <i>Fusarium</i> <i>Control:</i> Pre-dust seed with Thiram. Avoid over-watering while on the seedbed • Downy Mildew: <i>Symptoms:</i> Seedlings show white moulds halfway up the stem; leaves show watery spots on the underside when held against the sunlight and white spots on the upper side <i>Control:</i> Prevention: dust seed with Thiram. Prevention and cure: routine spray Ridomil MZ 72, at 25 g/10 litres of water, on crops grown between February and April as well as in areas were the disease is common • Black Rot: Caused by the bacteria <i>Xanthomonas campestris</i> <i>Symptoms:</i> Brown spots on the outside areas of the leaves and black spots on stems <i>Control:</i> Possible by antibiotics, since it is a bacterium, but they are expensive. Use Copper Oxychloride 85%, at 40 g/10 litres of water, to suppress, when the first signs of the disease are observed • Soft Rot: <i>Symptoms:</i> Rotting of leaves and stem. Very bad smell, especially during rainy season <i>Control:</i> No control possible 	

7.4. Carrot

Scientific name:	<i>Daucus carota</i>
Family:	<i>Umbelliferae</i>
Cultivars:	Chantenay, Cape Market and Nantes
Climate:	Carrots can be grown under a wide range of climatic conditions. The optimum temperature range for growth is 15-20°C. Germination and growth are retarded when weather conditions are cooler and frost damages the crop when it approaches maturity. If plants are exposed to temperatures of 5-15°C for a prolonged period, they will bolt and produce flowers. Temperatures exceeding 20°C lead to poor quality. Temperature has influence on the shape and colour of the carrot root. When temperatures are low, the colour is poor and the root longer than under optimum conditions. When temperatures are above 20°C, the colour deteriorates and the root becomes shorter and thicker. Moist, humid weather conditions expose them to diseases
Seed amount:	5 kg/ha
Planting depth:	2 cm. The final land preparation must be fine tilth, with the soil free of stones and plant debris. To sow thinly, mix 6:1 sand:seed. Thinning will be necessary to achieve 2.5 cm between the plants
Spacing:	30 cm between the rows and 2.5 cm within the row
Planting time:	Carrots can be cultivated all year round, but May to July is the best time for the Lowveld and April to December is the best time for the Highveld
Growth period:	About 4 months from sowing to harvest
Fertilizers:	<i>Basal application:</i> In good soils 400-600 kg/ha of Compound D or Compound L. In poor soils 800-1000 kg/ha of Compound D or Compound L <i>Top dressing:</i> 100 kg/ha AN, 4 weeks after sowing, preferably after thinning if the crop requires nitrogen. Avoid applying too much nitrogen as it promotes vegetative growth at the expense of the root tubers
Harvesting:	Starts 3 months after sowing or earlier, depending on market demands. Harvesting should be carried out during the cooler part of the day, very early in the morning or early in the evening. Keep the carrots in a cool place or

sprinkle with water to keep them in a fresh state. Package them in small amounts, for example pockets of 10 kg, to avoid bruises and breakage. Keep them cool and well ventilated until they reach the consumer. Keeping the leaves on increases the deterioration rate

- Expected yield: > 25 tons/ha
- Pests:
- Aphids: Found on the crown of the carrot, may be difficult to see
Symptoms: Presence of ants, poor leaf development and stunted growth
Control: Use Dimethoate 40 EC, at 10 ml/10 litres of water, when observed
 - Nematodes: Carrots are susceptible to nematode species. Quality loss can be very high in infested fields, since it is the tuber that is attacked
Control: Observe rotations
- Diseases:
- Leaf Blight: *Symptoms:* black foliage
Control: Routine spray fungicides like Dithane M45, at 20 g/10 litres of water, or Copper Oxychloride 85% WP, at 50 g/10 litres of water, once a week
 - Sclerotium sp: Soil-borne disease, attacking the roots and tubers
Symptoms: White spots in a white mycelium
Control: Apply Thiram at seedling stages by direct application or drenching
 - Powdery Mildew: *Symptoms:* Whitish powdery growth on the undersurface of the leaves. As the disease progresses, powdery spots appear on both surfaces of the leaves and on stems
Control: Allow good drainage and use fungicides like Benomyl, Dithane M45, and Copper Oxychloride when the first signs have been observed.



7.5. Cucumber

- Scientific name: *Cucumis sativus*
- Family: *Cucurbitaceae*
- Cultivars: Short cultivars: Cherkee, Victory, Ashely and Fletcher
Long Cultivars: Colorado, Marketer Long and Stono
- Soil: Cucumbers grow well in well drained soils. They are very sensitive to waterlogging. Optimum pH 5.5-6.5
- Climate: Cucumbers are warm season crops. They grow best in summer months, between August and April on the Highveld. They require 4-6 months of warm weather. Only in lower lying areas, like the Lowveld, may open field winter production be possible
- Seed amount: 2.5-3.0 kg/ha
- Planting depth: 2 cm. Direct seeding is the best
- Spacing: 1.20 m between the rows and 30 cm within the row. Avoid excessive watering and make sure the soils have good drainage since cucumbers are sensitive to wet feet or waterlogging. During the rain season, to facilitate good drainage, planting should be on raised beds 0.3 m high and 1.20 m wide, with a furrow in between of 0.5 m
- Planting time: Cucumbers are best grown in August after frost in frost-prone areas of the Highveld. In the Lowveld, the best time to produce is in winter
- Growth period: 4 months from planting
- Fertilizers: *Basal application:* 400-600 kg/ha of Compound D
Top dressing: 100 kg/ha of AN. To be applied twice after the first fruit set

Harvesting:	Cucumbers are harvested before they are physiologically fully mature and picking usually begins about 2 months after sowing and thereafter every few days	
Expected yield:	10-15 tons/ha	
Pests:	• Root-knot Nematode:	<i>Symptoms:</i> Swollen roots as well as a stunted plant <i>Control:</i> 4-year rotation, avoiding the Solanaceae family (tomato, potato, paprika, etc.)
	• Aphids	Suck sap while transmitting mosaic virus <i>Symptoms:</i> See under mosaic virus <i>Control:</i> Spray Dimethoate 40 EC, at 7.5 ml/10 litres of water, when observed on plants
	• Red Spider Mite:	<i>Symptoms:</i> Leaves loose colour, curling and drying of the leaves <i>Control:</i> Spray Nuvacron 40, at 50 ml/10 litres of water, when observed on plants
Diseases:	The main diseases attacking cucumbers and all Cucurbits in general are as follows:	
	• <i>Fusarium</i> wilt:	Soil-borne disease. Takes about 2 weeks to develop <i>Symptoms:</i> Leaves start wilting, followed by leaf necrosis of the older leaves <i>Control:</i> Dust seed with Thiram and use resistant cultivars
	• Anthracnose:	Appears in wet weather conditions <i>Symptoms:</i> Black spots on leaves, leaf stalks and stem as well as sunken lesions on the fruits, spores on mycelium visible <i>Control:</i> Apply Dithane M45, at 20 g/10 litres of water, when symptoms appear
	• Powdery Mildew:	<i>Symptoms:</i> Clear light green spots visible on the upper surface of the leaves, which later turn to white powdery spots on the leaves; brown colouring of the leaves from the edge <i>Control:</i> Use systemic fungicides, for example Bavistin at 5 g/10 litres of water, once a week when the first signs are noticed
	• Downy Mildew:	<i>Symptoms:</i> Circular brown spots on the leaves with a yellowish halo. In advanced stages the attack looks like frost damage <i>Control:</i> Use systemic fungicides like Ridomil MZ 72 WP, at 25 g/10 litres of water, once a week or use Copper Oxychloride 85% WP, at 40 g/10 litres of water, once a week when the symptoms appear
	• Cucumber mosaic virus:	<i>Symptoms:</i> Chlorotic mottling streaking pattern of yellow and green areas occurring on young leaves, followed by leaf malformations as well as stunting. Plants becoming bushy. On the fruits are yellowish green mottles at the stem end covering the whole fruit. The infected cucumber has a bitter taste <i>Control:</i> Control the vector, which usually are aphids. Rogue out and destroy all infected plants when attack has been detected

7.6. Garlic

Scientific name:	<i>Allium sativum</i>
Family:	<i>Liliaceae (Allium)</i>
Cultivars:	Vegetatively propagated from cloves. Select healthy thick cloves for planting
Soil:	Garlic can be produced in a wide range of soils, provided they are deeper than 50 cm. Sandy loam or clay loam soils give the best results, heavy soils restrict normal bulb expansion. Optimum soil pH 5-5.5. Apply lime when pH falls below 5, 2-3 months before planting
Climate:	Garlic requires long days and high temperatures, which influence the bulbing. High temperatures also hasten bulb maturity. Exposure to cold temperatures is essential for bulb initiation. Cloves should be planted just before winter for them to bulb. Alternatively store bulbs at 0-10°C for 1-2 months and plant in spring. Garlic is very hardy and can withstand fairly severe frost
Seed amount:	Plant single cloves, approximately 900-1120 kg/ha of sets is required
Planting depth:	Top just sticks out
Spacing:	30 cm between the rows and 5-10 cm within the row
Planting time:	Garlic is frost hardy, bulbing occurs during longer days and higher temperatures and subsequent exposure to lower temperatures. Plant in April-May for best results, although planting can be achieved throughout the dry season in the Highveld
Growth period:	Bulbs begin to mature 4 months after planting
Fertilizers:	Garlic responds well to the application of organic manure, 30 tons/ha <i>Basal application:</i> 500 kg/ha of Compound S or Compound D <i>Top dressing:</i> 290 kg/ha of AN, split in 2-3 times
Harvesting:	When the tops begin to dry and the necks drop, it is time to lift the bulbs. The bulbs are cured in the field for about a week until they are dry. Storage can be for several weeks to months

Expected yield:	30 tons/ha or more
Pests:	<ul style="list-style-type: none"> • Thrips: <i>Symptoms:</i> Damage on leaves in form of silvery spots and streaks <i>Control:</i> Apply Thiodan 50 WP, at 10 g/10 litres of water, once the insects have been seen • Cutworm: Greasy greyish-green worm that feeds at night and retreats into the soil during the day <i>Symptoms:</i> Chewing holes through the detached stem <i>Control:</i> Apply Thiodan 50 WP, at 10 g/10 litres of water, after planting • Webworm: <i>Symptoms:</i> A creamy pink caterpillar that eats out the heart of the plant <i>Control:</i> Spray Thiodan 50 WP, at 10 g/10 litres of water, when observed • Leaf Miners: <i>Symptoms:</i> Small transparent-like tunnels through the leaf membrane <i>Control:</i> Spray Dimethoate 40 EC, at 7.5 ml/10 litres of water, when symptoms appear
Diseases:	Garlic is not very susceptible to many diseases. Most of the onion diseases can attack garlic
	<ul style="list-style-type: none"> • Downy Mildew: Common when the weather is wet with high humidity <i>Symptoms:</i> A violet greyish mould can be seen on the leaves <i>Control:</i> Spray with Ridomil when symptoms have been observed • Purple Blotch: <i>Symptoms:</i> Drying of leaves from top with white sunken spots on the leaves, becoming purple with yellow halo <i>Control:</i> Spray Dithane M45, at 20 g/10 litres of water, or Bravo, at 10 ml/10 litres of water, when first signs of attack are noticed • Neck Rot and Black Moth: Are some of the most destructive pathogens during storage <i>Symptoms:</i> Bulbs turn black <i>Control:</i> There is no cure, except to store the bulbs under low temperature and keep the room well ventilated

7.7. Okra

Scientific name:	<i>Abelmoschus esculentus</i>
Family:	<i>Malvaceae</i>
Cultivars:	The most common improved variety is the American variety, Crimson spineless. Many smallholder farmers use seed of local varieties
Soil:	Okra grows well in soils that are well-drained, sandy loam, with an optimum pH of 6-6.8. Okra does not grow well on clay soils, waterlogged soils or acidic soils
Climate:	Okra is a warm season crop, sensitive to frost. Growth is affected when temperatures fall below 20°C. It thrives where there is a lot of sunshine
Seed amount:	8-10 kg/ha. Pre-soaking of seed does not only improve the germination percentage, but also reduces the days to seed emergence. Okra needs warm soils for good germination and mean monthly temperatures around 20-30°C
Planting depth:	2-3 cm
Spacing:	60-90 cm between the rows and 20-30 cm within the row
Planting time:	Highveld: Plant in September-December after the frost period. In the Lowveld it can be a year-round crop
Growth period:	60-180 days from planting to harvesting, depending on the variety
Fertilizers:	<i>Basal application:</i> 450-750 kg/ha of Compound C or Compound D <i>Top dressing:</i> 290 kg/ha of AN, split in 3 times starting 3 weeks after germination
Harvesting:	Harvest the young pods 5-10 days after flowering before they get fibrous. Harvest can continue for more than 2 months
Expected yield:	2 tons/ha
Pests:	<ul style="list-style-type: none"> • Aphids: <i>Symptoms:</i> Sticky sugary cover on the leaves and stem. Retarded plant growth <i>Control:</i> Use Dimethoate 40 EC, at 10 ml/10 litres of water, when the first signs of attack are observed • Root-knot Nematode: This is a very serious problem on okra <i>Symptoms:</i> Stunted plants, swollen roots <i>Control:</i> Observe a 4-year rotation excluding other nematode susceptible crops. Crops from the <i>Alliaceae</i> family, like onion, garlic, leeks and shallots, as well as maize are good cleaning crops
Diseases:	<ul style="list-style-type: none"> • <i>Verticillium</i> wilt: Indicates the presence of nematodes, since it is a saprophyte of nematodes <i>Symptoms:</i> The vascular system turns brown, resulting in the general wilting of the plant. <i>Control:</i> Observe rotations and hygienic practices as well as treating the seed with Thiram • <i>Cercospora</i> Leaf Spot: <i>Symptoms:</i> Brown spots on leaves with middle part of spot being white <i>Control:</i> Apply Dithane M45, at 20 g/10 litres of water, or Copper Oxychloride 85% WP, at 40 g/10 litres of water, when the symptoms appear

7.8. Onion

Scientific name: *Allium cepa*

Family: *Alliaceae*

Cultivars: Bon Accord, Hojem, Pyramid, Texas Grano and many hybrid cultivars on the market

Soil: Onions can be grown on a wide range of soils, varying in texture from coarse-grained sands to clays. Lighter soils are easy to manage. Soils should be 45-60 cm deep and well drained. The most suitable pH is 5-6. When pH falls below the minimum level, apply lime a month before planting

Climate: Light and temperature influence the process of bulbing. Both factors must be at optimum for the initiation of the bulbs. Cool conditions with long days are normally important for production, although there are cultivars that tolerate warm conditions and short day-lengths. Cool conditions are usually required during the first part of the season, when the plants start to form bulbs. Warm and dry weather is needed for harvesting and curing. Each cultivar differs in its sensitivity to day-length. In Zimbabwe and most countries in southern Africa mostly short day-length types grow

Temperature is one of the most important factors in initiating and influencing the rate of bulbing. For any given day-length, high temperatures ensure early bulb initiation and more rapid bulb formation. A short day-length cultivar will start bulbing earlier and produce a crop quicker when grown at low altitude than it will when grown at the same altitude, but in a cooler locality. Temperature determines the marketing prospects for onions grown in any particular area and will influence the selection of the production technique to be adopted by the grower. Temperature will also influence flowering. Since the onion is biennial in growth habit, flowering does not occur until the second year. Fluctuating cold and warm weather during the first growing season will, however, initiate flowering and thereby cause plants to bolt. Bolting may be quite common in cool areas that have a mean winter temperature of 7-12.5°C, because the proportion of plants exhibiting the symptom is dependent upon the degree to which temperatures fluctuate around the mean and depends on the cultivar used. Low temperatures inhibit bolting

Seed amount: 3 kg/ha on 300 m² of seedbeds. The seedbeds can be arranged in 10 beds of 30 m long by 1 m wide each. Sow in rows 15 cm apart, 1 cm deep at a rate of 10 g of seed per m². Incorporate 500 g/10 m² of Compound S in the seedbed prior to sowing. Apply 350 g/m² of AN after 3 weeks in the nursery

Planting depth: When planting the seedling, just bury the roots and leave the shoot to fall with the bulb sitting on top of the ground. After a week they will all stand upright. Avoid planting too deep

Spacing: Transplant 8 weeks after sowing, when plants are 5-7 mm thick or pencil thickness. 30 cm between the rows, 5-7 cm within the row

Planting time: Highveld: From March to June. Lowveld areas best plant in April-May

Growth period: After transplanting it takes 4-6 months for the onion to mature, depending on the cultivar

Fertilizers: *Basal application:* 600-1000 kg/ha Compound S or Compound D
Top dressing: 150 kg/ha AN twice, at 4 weeks and at 8 weeks after transplanting

Harvesting: Lift when 50-90% of the necks have collapsed and leave to cure in the field until the tops have dried for at least 2 weeks, and another 2 weeks of curing, grading and packaging/or storage in the shed. Onion for bulbs should be harvested in October, when the conditions are dry. Drying can be done in tobacco barns. Green onions with developed bulbs can be sold 3 to 4 months after transplanting

Expected yield: 50-90 tons/ha, depending on the cultivar

- Pests:
- Thrips: *Symptoms:* Damage on leaves in form of silvery spots and streaks
Control: Apply Thiodan 50 WP, at 10 g/10 litres of water, once the insects have been seen
 - Cutworms: Greasy greyish-green worm that feeds at night and retreats into the soil during the day
Symptoms: Chewing holes through the detached stem
Control: Apply Thiodan 50 WP, at 10 g/10 litres of water, after planting
 - Webworm: *Symptoms:* A creamy pink caterpillar that eats out the heart of the plant
Control: Spray Thiodan 50 WP, at 10 g/10 litres of water, when observed
 - Leaf Miners: *Symptoms:* Small transparent-like tunnels through the leaf membrane
Control: Spray Dimethoate 40 EC, at 7.5 ml/10 litres of water, when symptoms appear
- Diseases:
- Damping Off: Seedlings die in big numbers, enhanced by wet conditions. It is mainly caused by *Rhizoctonia* sp., *Pythium* sp. and *Fusarium*, as well as other fungal diseases
Symptoms: Seedlings fall just above soil level
Control: Apply Thiram as a dust on seeds before sowing and dip seedlings in a Thiram solution at transplanting
 - Soft Rot: This is a bacterial disease, caused by *Erwinia* sp. on the bulb
Symptoms: Soft bulb as well as cracks starting from the top
Control: There is no control except hygiene

- Downy Mildew: This is common when the weather is wet with high humidity
Symptoms: Leaves covered by a violet greyish mould
Control: Spray Ridomil MZ 72 WP, at 25 g/10 litres of water, once a week. Can also use Dithane M45 or Copper Oxychloride when symptoms appear
- Purple Blotch: *Symptoms:* Drying of leaves from top with white sunken spots on the leaves, becoming purple with yellow halo
Control: Spray Dithane M45, at 20 g/10 litres of water, or Bravo, at 10ml/10litres of water, once a week where the disease is a common problem
- Bulb Rot: It is a storage disease, commonly caused by *Sclerotium cepivorum*
Symptoms: Bulbs turning black in storage
Control: When in storage, it is too late to control, select and destroy infected bulbs

7.9. Paprika

- Scientific name: *Capsicum annuum L.*
- Family: *Solanaceae*
- Cultivars: Papri-King and Papri-Queen
- Soil: Well-drained fertile soils with a pH range of 5.5-7.5. The crop is very sensitive to waterlogging. Best grown in sandy loam and clay loam soils with good drainage and aeration. Usually planted on ridges
- Climate: Paprika is sensitive to frost and grows best when temperatures are above 15°C. Optimum growth occurs at 24-30°C, poor growth occurs when temperatures are between 4-15°C. Day temperatures above 32°C and night temperatures below 16°C prevent fruit set. Low humidity and high temperatures cause abscission of buds, flowers and small fruit
- Seed amount: 700 g/ha
- Seedbeds: Sowing of seedbeds must not begin before 1 June. Seedbed area: four beds measuring 29 m long x 1.2 m wide each, giving an area of 34.8 m² each, will provide adequate seedlings to plant a hectare. Seedling spacing: 5-10 cm between the rows and 2-3 cm within the rows. The nursery rotation and hygiene recommended in Chapter 6 should be followed. Solarization and fumigation are also necessary measures, as discussed earlier. While the seedlings are still in the nursery, it is important to weed and spray against pests and diseases
- Transplanting: Transplanting in the field must not be done before 1 September and must be completed by 1 January, when seedlings are 15-20 cm high or pencil thickness, 6-8 weeks after sowing. Transplanting in September-October will give best yields. Seedlings should be hardened before transplanting
- Spacing: 90 cm between the rows, 20 cm within the row. Paprika is grown in one row on raised ridges or in two rows on raised beds. Plant population is 55 000-65 000 plants/ha
- Growth period: 7 months
- Fertilizers: *Basal application:* 700 -1000 kg/ha of Compound S or Compound L
Top dressing: 250-350 kg/ha of AN, split 5-6 times: 1st application 4 weeks after transplanting (50 kg/ha), 2nd application 8 weeks after transplanting (50 kg/ha), 3rd application 12 weeks after transplanting (50kg/ha), 4th application 16 weeks after transplanting (50kg/ha), 5th application 20 weeks after transplanting (50kg/ha). 350-400 kg/ha Muriate of Potash, split twice: 1st application 4-5 weeks after transplanting (150-200 kg/ha), 2nd application 4 weeks after the first one (150-200 kg/ha)
- Harvesting: When the pods turn dark red and wrinkled, so that it can be wrapped around the two fingers without snapping, the pods are ready for harvest
- Expected yield: Yields of dry pods are 2.8-5.6 tons/ha
- Pests:
- Cutworms: *Symptoms:* Plants chewed through stems near the soil line
Control: Spray with Malathion 25% WP, at 20 g/10litres of water, after seed emergence
 - Bollworm, Budworm, Fruitworm: *Symptoms:* Fruit damage, deep watery cavity contaminated with faeces and cast skin
Control: Spray Karate (for rate see label), from 1 February to 31 March only
 - Aphids: *Symptoms:* Stunted plants; distortion and mottling of younger leaves, which become cupped
Control: Spray Dimethoate or Orthene
 - Mites: *Symptoms:* Curled leaves giving an inverted spoon appearance
Control: Spray Metasystox
- Diseases:
- Damping Off: *Symptoms:* Rotting and wilting of seedlings.
Control: Spray Copper Oxychloride, at 30 g/10 litres of water, after the seed have emerged

Figure 8**Bacterial spot on paprika leaf and fruit (Source: University of Florida, 2000)**

a. Bacterial spot on a paprika leaf



b. Bacterial spot on a paprika fruit

- Late Blight
Phytophthora sp: *Symptoms:* Dark brown stem necrosis extending upwards from the soil. Sudden wilting of the entire plant without leaves turning yellow. Water-soaked, dull green spots on pods that spread rapidly to the entire plant
Control: Spray Copper Oxychloride, at 30 g/10 litres of water
- Bacterial wilt: *Symptoms:* Wilting of lower and upper leaves in young plants. Sudden wilting of the entire plant
Control: Observe hygiene and spray Copper Oxychloride, at 30-40 g/10 litres of water, at the first sign of infection
- *Fusarium* wilt: *Symptoms:* Slight yellowing of foliage and wilting of upper leaves
Control: Spray Lime Sulphur and Dithiocarbamate (for rates see label)
- *Verticillium* wilt: *Symptoms:* Wilting and upward curling of lower leaves as well as a stunted plant growth
Control: Spray Lime Sulphur and Dithiocarbamate (for rates see label)
- Bacterial Spot: *Symptoms:* Circular, water-soaked leaf lesions that become necrotic with brown centres. Defoliation is common. Raised brown lesions that are wart-like in appearance on fruit
Control: Observe rotations and apply Copper Oxychloride, at 30 g/10 litres of water. This reduces the rate of the disease development
- Blossom end rot: This is a physiological disorder, caused by deficiencies of calcium
Symptoms: Water-soaked areas, which later turn brown-black. These develop near the blossom end and never at the tip of the pod
Control: Liming and good water management

7.10. Pea

Scientific name: *Pisum sativum*

Family: *Leguminosae*

Cultivars: Green feast. Check with local seed companies for cultivars presently available. Difference should be made between garden fresh peas and canning peas. There are early maturing (2.5 months) and later maturing (3.5 months) cultivars

Soil: Peas can grow on a wide range of soils, but fertile sand loams to light clays are best. The soils must be well-drained and deep, up to 90 cm. Optimum pH 5.5-6.0. Apply lime when pH falls below 5.5, prior to planting

Climate: Peas grow best in moderate climatic conditions, they do not do well under high temperatures. Best production in areas with temperatures of about 23°C. Best yields obtained when mean monthly temperatures are 13-20°C. Temperatures below 5°C result in poor germination and growth. Temperatures above 27°C after flowering, even for a short period, will result in pods that mature quickly reducing yield and quality. Flowering and pod setting are sensitive to water stress

Seed amount: For the fresh pea production: 30-40 kg/ha. For the processing of dry pea: 80-120 kg/ha

Spacing: Fresh peas: 30 cm between the rows, 5 cm within the row. Canning peas: 20 cm between the rows, 2.5-5 cm within the row

Planting time: Peas require a cool, relatively humid climate and are therefore confined to higher altitudes (> 1200 m) in the tropics or, if the climate is cool enough, they can be grown during winter. March-April plantings are recommended. Late planted peas (end of May) can suffer from frost in their sensitive stage (flowers and green pods)

Growth period: Early maturing garden peas 2.5-3.5 months

Fertilizers: *Basal application:* 500 kg/ha of Compound S

Top dressing: Peas are capable of fixing atmospheric nitrogen. However, a starter dose of 50 to 100 kg AN is beneficial for good early growth

Harvesting:	Picking can start 2 months after planting for early maturing cultivars and 2.5 months after planting for late-maturing cultivars and can continue for a month, picking once or twice a week. Late-maturing dry peas take 3-3.5 months	
Expected yield:	5-10 tons/ha	
Pests:	• Aphids:	<i>Symptoms:</i> Leaves curl and dry, due to sucking of sap <i>Control:</i> Spray Thiodan, at 12 g/10 litres of water, or Dimethoate 40 EC, at 10 ml/10 litres of water, or Malathion 50%, at 20 g/10 litres of water
	• Red Spider Mite:	<i>Symptoms:</i> Little red mites, mostly on underside of the leaves, causing silverish mottles on leaves <i>Control:</i> Use Nuvacron 40, at 50 ml/10 litres of water
	• Caterpillars:	These attack at night. Can be dark green or brownish with lighter stripes <i>Symptoms:</i> Holes in leaves or buds eaten <i>Control:</i> Use Carbaryl 85% WP, at 20 g/10 litres of water, or chemicals listed under aphids
	• Nematodes:	<i>Symptoms:</i> Plants do not grow well, roots show small gall groups <i>Control:</i> Observe 3-4 year rotation and do not rotate with other nematode sensitive crops
Diseases:	• Powdery Mildew:	<i>Symptoms:</i> White powder on leaves <i>Control:</i> Spray with Bayleton 5% WP, at 20 g/10 litres of water, or Sulphur 50% WP, at 20 g/10 litres of water
	• Damping Off:	<i>Symptoms:</i> Rotting of seedlings before emergence <i>Control:</i> Dust seed with Thiram, at 20 g/10 kg of seed
	• Downy Mildew:	<i>Symptoms:</i> Typical blue-greyish cover on leaves <i>Control:</i> Use Dithane M45, at 20 g/10 litres of water
	• <i>Fusarium</i> wilt:	<i>Symptoms:</i> Browning of lower leaves, wilting of the plant <i>Control:</i> Dust seed with Thiram

7.11. Pea – Mange tout

Scientific name:	<i>Pisum sativum</i> var <i>Mange tout</i>	
Family:	Leguminosae	
Cultivars:	Mange tout and Sugar snap	
Soil:	Peas can grow on a wide range of soils, but fertile sand loams to light clays are best. The soils must be well drained and deep, up to 90 cm. Optimum pH 5.5-6.0. Apply lime when pH falls below 5.5, prior to planting	
Climate:	Peas grow best in moderate climatic conditions, they do not do well in high temperatures. Best production in areas with temperatures of about 23°C. Best yields obtained when mean monthly temperatures are 13-20°C. Temperatures below 5°C result in poor germination and growth. Temperatures above 27°C after flowering, even for a short period, will result in pods that mature quickly reducing yield and quality. Flowering and pod setting are sensitive to water stress	
Seed amount:	35-50 kg/ha	
Spacing:	Beds 90 cm wide, 45 cm between the rows, 5 cm within the rows.	
Planting time:	March-September	
Growth period:	Mange tout is grown for its immature and seedless pods. Sugar snap is grown for its immature seeds when the sugar content is very high	
Fertilizers:	<i>Basal application:</i> 500 kg/ha of Compound S <i>Top dressing:</i> 100-200 kg AN at flowering. Foliar application is also advised depending on the state of the crop	
Harvesting:	Harvesting should be done as soon as the pods have reached the required size. The stage of harvesting the immature pods is determined by the market for both Mange tout and Sugar snap. The pods should be straight without any blemish, 6-8 cm long and uniform	
Expected yield:	4-8 tons/ha	
Pests:	• Cutworms <i>Agrotis</i> sp:	<i>Symptoms:</i> Plants chewed through stems near the soil line <i>Control:</i> Drench with Malathion, at 20 g/10 litres of water, when symptoms are observed
	• <i>Heliothis</i> Bollworm:	<i>Symptoms:</i> Holes in leaves or pods eaten <i>Control:</i> Spray Carbaryl 85% WP, at 20 g/10 litres of water, when symptoms have been seen
	• Nematodes:	<i>Symptoms:</i> Plants do not grow well, roots show small gall groups <i>Control:</i> Observe rotations, every 3-4 years, and do not rotate with other nematode sensitive crops

- Red Spider Mite: *Symptoms:* Little red mites, mostly on underside of the leaves, making silverish mottles on leaves
Control: Spray Nuvacron 40, at 50 ml/10 litres of water, at the first sign of infestation
 - Thrips: *Symptoms:* White spots with a small hole in the centre
Control: Spray Kocide and Thiodan, at 10 g/10 litres of water, when symptoms appear
- Diseases:
- Powdery Mildew: *Symptoms:* Raised spots with small volcano cone at the top; white powder on leaves
Control: Spray Bayleton 5% WP, at 20 g/10 litres of water, or Sulphur 50% WP, at 20 g/10 litres of water, or Benlate. Chemical control should be done when the first symptoms are observed
 - Damping Off: *Symptoms:* Rotting of seeds before emergence
Control: Dust seed with Thiram, at 20 g/10 kg of seed
 - Downy Mildew: *Symptoms:* Typical blue-greyish cover on leaves
Control: Apply Dithane M45, at 20 g/10 litres of water

7.12. Potato

Scientific name: *Solanum tuberosum*

Family: *Solanaceae*

Cultivars: BPI, Amythest, Mont Claire, Jacaranda

Soil: Potatoes can grow in a wide range of soils, but the best soils are medium-textured loamy soils with good organic matter content. Heavy clays can become hard, producing misshapen tubers, although yield can be high. Optimum soil acidity is pH 5-5.5. Avoid applying lime to a potato crop, since this may cause a disease called potato scab. Lime should be applied to other crops before potatoes. Soil depth should be at least 60 cm. In areas where nematodes are suspected, soils should be fumigated before planting

Climate: Tubers are not produced if temperatures are high at the critical time of tuber initiation or if the plants are killed by frost. Mean optimum temperatures for tuber production are 15-20°C. With temperatures above 32°C both tuber formation and yield are poor

Seed amount: 160 pockets of 15 kg each (there are normally about 200 tubers in 1 pocket of 15 kg). Seed potatoes are usually un-sprouted when purchased. Sprouting should be done under daylight conditions. Protect only from very strong sun. Rain does no damage if it drains from the tubers. When tubers and sprouts turn green it makes them both tougher and less liable to damage

Planting depth: 5-10 cm

Spacing: 90 cm between the rows, 30 cm within the row. If enough funds are available for seed tubers, spacing can be reduced to 80 cm or even 60 cm between the rows and 30 cm within the row (210 and 280 pockets respectively)

Planting time: Potatoes can be planted 3 times a year in the Highveld. Summer crop: November-March. First winter crop: February-June. Second winter crop: August-December

Growth period: 4.5 months

Fertilizers: *Basal application:* 600-1000 kg/ha of Compound S or Compound D
Top dressing: 290 kg/ha of AN applied once, 3 weeks after emergence

Cultural practices: After applying the top dressing, potatoes should be ridged up to 20-30 cm high. The first ridging will be the first weed control. The second ridging should be done after potato tubers have started to break the soil

Harvesting: When 90% of the tops have dried or have changed colour to pale yellow, stop irrigation and cut and remove all the tops. Burn them when they are dry to control diseases. Leave the tubers in the ground for 15 days before lifting. It is best to lift using a garden folk

Expected yield: Summer crop: 17-20 tons/ha. Winter crop: 25-30 tons/ha. Yields above 40 tons/ha are possible. In the Mediterranean basin yields of up to 70 tons/ha are common

- Pests:
- Nematodes: *Symptoms:* Raised and cracked spots of tubers
Control: Chemical treatment is too expensive. Observe rotation every 4 years
 - Potato tuber moth: *Symptoms:* Larvae make tunnels in plant tissue; wilting and drying off of tops as nutrient flow is cut off; tunnels in tubers
Control: Biological through introduction of parasitic wasp. Chemical use of Azodrin 40, at 15 ml/10 litres of water, when symptoms appear
 - Aphids: *Symptoms:* Poor leaf development
Control: Spray every 10 days Azodrin 40, at 15 ml/10 litres of water

Diseases:

- Bacterial wilt: Wilting plants here and there in the population is a very characteristic indication
Symptoms: Plants wilt as if they have a lack of water
Control: Use resistant varieties

- Late Blight: Occurs when the relative humidity is more than 70% and temperature is around 22-25°C Very quick spreading (a whole field in one week) during the wet season
Symptoms: Brown patches at end of leaves with white mycelium on underside; brown spots on stems
Control: Use Dithane M45 and Ridomil MZ 72 combined. Two sprays of Dithane alternated with two sprays of Ridomil. Spray every 10 days with Dithane, at 20 g/10 litres of water, and Ridomil MZ 72, at 50 g/10 litres of water
- Early Blight: Slow spreading at temperature around 25°C. During wet and dry season
Symptoms: Bottom leaves show concentric necrotic spots
Control: In the same way as late blight

7.13. Rape and Kale

Scientific name:	<i>Brassica napus</i> and <i>Brassica acephala</i> var <i>Portuegeuse kale</i>
Family:	<i>Brassicaceae/Cruciferae</i>
Cultivars:	English Giant Rape. Kale: Covo Troncuda. Rugare-Viscose, which is vegetatively propagated
Soil:	Rape and kale grow well in most soils, provided they are well-drained and rich in organic matter. Well-drained sandy loams are the best soils. The optimum pH is 5.5-7.0
Climate:	Both rape and kale are cold tolerant plants and best results are obtained in areas with cooler weather. Viscose thrives well during the rainy season in the Highveld
Seed amount:	In situ: 5 kg/ha. In seedbeds: 0.5 kg for 1 ha of transplanted seedlings
Planting depth:	1-3 cm
Spacing:	30-75 cm between the rows and 30-50 cm within the row. Transplant when plants are 5-10 cm high. With direct seeding in the case of rape, thinning is required after 3-4 weeks. Rugare uses wider spacing
Planting time:	Best grown in winter. Best in cool moist climates in both Lowveld and Highveld
Growth period:	Rape needs only 4-5 weeks after transplanting and harvest continues for 3-4 months. Kale takes 3 months and harvest continues over several months, depending on management (Rugare-Viscose)
Fertilizers:	All <i>Brassicaceae</i> respond very well to applications of organic manure or compost. If the quality of manure is high, then reduce application of inorganic fertilizers. Apply 30-50 tons/ha <i>Basal application:</i> 700 kg/ha of compound L. High Boron content is needed, since <i>Brassicaceae</i> are sensitive to Boron deficiencies <i>Top dressing:</i> 100 kg/ha of AN every 3 weeks
Harvesting:	Rape harvest 5-6 weeks after transplanting, for 3-4 months. Kale takes 2-3 months before harvesting
Expected yield:	Varies with management, 25-50 tons/ha
Pests:	<ul style="list-style-type: none"> • Aphids: <i>Symptoms:</i> Stunted growth, inside curled leaves with aphids on growing tips and on tender leaves <i>Control:</i> Use Dimethoate 40 EC, at 10 ml/10 litres of water, when the insects have been observed on a few plants • Spider Mite: <i>Symptoms:</i> Little red mites, mostly on the underside of the leaves making small webs, sucking insects, making leaves dry and stem curly in later stage <i>Control:</i> Use Nuvacron 40, at 50 ml/10 litres of water, when the first signs are detected • Diamondback Moth: <i>Symptoms:</i> Bright green caterpillar eating on leaves <i>Control:</i> Use Carbaryl 85% WP, at 20 g/10 litres of water, when small green caterpillars are observed often covered in a web
Diseases:	<ul style="list-style-type: none"> • Downy Mildew: Attacks seedlings as well as mature plants <i>Symptoms:</i> White molds on cotyledons and stem; watery spots on underside of leaves (can be seen when holding leaves against sun); white spots on the upper side leaf <i>Control:</i> Prevention by Thiram or Captan or Quintozene. Cure with Ridomil MZ 72, at 25 g/10 litres of water, when symptoms appear • Black Rot: <i>Symptoms:</i> Black spots on the outside of leaves and stem <i>Control:</i> Spray Copper Oxychloride 85%, at 40 g/10 litres of water, when symptoms appear • Damping Off: By <i>Rhizoctonia</i>, <i>Pythium</i>, <i>Phytophthora</i>, <i>Alternaria</i>, <i>Fusarium</i> <i>Symptoms:</i> Bottom of the seedling is damaged and falls <i>Control:</i> Dust seeds with Thiram, spray with Dithane M45 or Copper Oxychloride • Soft Rot: Bacterial disease caused by <i>Erwina carotovora</i>, hence no chemical treatment available <i>Symptoms:</i> Rotting of leaves and stem. A very bad smell is a typical indication. Appears especially during rainy season <i>Control:</i> No treatment possible

7.14. Squash-Pumpkin

Scientific name:	<i>Cucurbita maxima</i> and <i>Cucurbita moschata</i>
Family:	<i>Cucurbitaceae</i>
Cultivars:	Squash belong to the genus <i>Cucurbita</i> under the family of the <i>Cucurbitaceae</i> . This class refers to squash, pumpkin, marrow and courgette. Since their uses and husbandry are much the same, they are treated as a group
Soil:	Pumpkins grow well in well-drained soils. They are very sensitive to waterlogging. Optimum pH is 5.5-6.5
Climate:	Pumpkins are warm season crops. They grow best in summer months, from August to April in the Highveld. They require 4-6 months of warm weather. Only in the Lowveld may winter production be possible
Seed amount:	3-4 kg/ha
Planting depth:	2-3 cm
Spacing:	For long-running cultivars: when using the furrow method, 2.5 m between the rows and 1.2-2 m within the row. For small-vine and bush cultivars, 1.5 m between the rows and 1 m within the row. As for cucumbers, over-watering should be avoided. Planting on hills, 1.2 m apart for bush cultivars, up to 3 m apart for long runners, can be practiced when the growing season extends into the rainy season
Planting time:	Highveld, from the end of August. Winter production possible in Lowveld. Being warm climate plants, the higher the temperatures (not exceeding 25°C by day), the faster the growth
Growth period:	Mature fruits take up to 4 months
Fertilizers:	<i>Basal application:</i> 600 kg/ha of Compound D <i>Top dressing:</i> 100 kg/ha of AN after the first fruit setting and another 100 kg/ha of AN three weeks after the first one
Harvesting:	For most of the <i>Cucurbita</i> , immature fruits are wanted (before the rind hardens). The first usable fruits are harvested 7-8 weeks after planting (for example baby marrows or courgettes), bearing fruits for several weeks. Mature fruits take up to 4 months
Expected yield:	Squash: 11-16 tons/ha. Pumpkin: 18-22 tons/ha. Baby marrow: 2.2-4.5 tons/ha
Pests:	<ul style="list-style-type: none"> • Root-knot nematode: <i>Symptoms:</i> Swollen roots as well as a stunted plant <i>Control:</i> Observe a 4-year rotation, avoiding the Solanaceae family (tomato, potato, paprika, etc.) • Aphids: Suck sap while transmitting mosaic virus <i>Symptoms:</i> Stunted growth, inside curled leaves with aphids at growing tips <i>Control:</i> Spray Dimethoate 40 EC, at 7.5 ml/10 litres of water, when observed on plants • Red Spider Mite: <i>Symptoms:</i> Small reddish insects on the underside of the leaves, causing leaves to loose colour curling and drying of the leaves <i>Control:</i> Spray Nuvacron 40, at 50 ml/10 litres of water, when observed on the plants
Diseases:	<ul style="list-style-type: none"> • <i>Fusarium</i> wilt: Soil-borne disease, takes about 2 weeks to develop <i>Symptoms:</i> Leaves start wilting, followed by leaf necrosis of the older leaves <i>Control:</i> Dust seed with Thiram and use resistant cultivars • Anthracnose: Appears in wet weather conditions <i>Symptoms:</i> Black spots on the leaves, leaf stalks and stem as well as sunken lesions on the fruits; spores on mycelium visible <i>Control:</i> Apply Dithane M45, at 20 g/10 litres of water • Downy Mildew: <i>Symptoms:</i> Circular brown spots on the leaves with a yellowish halo. In advanced stages the attack looks like frost damage <i>Control:</i> Use Ridomil MZ 72 WP, at 25 g/10 litres of water, once a week or use Copper Oxychloride 85% WP, at 40 g/10 litres of water, once a week

Figure 9

Downy Mildew and Powdery Mildew on squash leaves (Source: University of Florida, 2000)



a. Downy Mildew



b. Powdery Mildew

- Powdery Mildew: *Symptoms:* White powdery spots on the leaves; brown colouring of the leaves from the edge
Control: Use Bavistin at 5 g/10 litres of water, once a week
- Cucumber mosaic virus: *Symptoms:* Chlorosis of the leaves
Control: Control the vector, which are usually aphids. Rogue out and destroy all infected plants

7.15. Tomato

Scientific name: *Lycopersicon esculentum* (L.)

Family: *Solanaceae*

Cultivars: *Determinate:* Roma, Rossol, Floridade, Rodade
Indeterminate: Money maker, Red Khaki, Heinz

Determinate varieties typically spread laterally and therefore do not need staking. Tomatoes on determinate plants also tend to ripen together, a good choice if intending to process or can the tomatoes. Indeterminate varieties continue to grow until the bitter end and need to be staked or trellised for best production (see below)

Soil: Tomatoes can grow well in a wide range of soils from sandy-loams to clays. Soil depth should be 60 cm and the soil well-drained. Growth is best in lighter soils, sandy loams to clay loams. Heavy soils that get waterlogged during the rainy season must be avoided. Optimum soil pH 5-6.5. Apply lime when pH falls below 5

Climate: *Temperature:* Tomatoes are very frost sensitive and require warm weather for 4.5 months. Seed germinates best at temperatures between 15-25°C. At 10°C seeds will take a very long time to germinate (20 days). When temperature exceeds 35°C germination becomes very poor. Maximum growth for both vegetative and fruiting occurs when minimum day temperatures do not fall below 21°C and minimum night temperatures do not fall below 15°C. High day temperatures cause blotchy ripening and soft fruit. Low temperatures increase the incidence of badly-shaped and poor quality fruit. Temperature is an important factor influencing fruit set. Best results are achieved when temperatures are between 18-20°C. Tomato is not a day-length sensitive crop.
Humidity: Hot dry spells, followed by heavy rain, cause the ripening fruit to crack. Moist overcast weather conditions cause fruit splitting, foliar and fruit diseases and delayed ripening

Seed amount: A hectare will require about 160 g of seed, 60 m² of seedbed: 6 beds of 10 m x 1 m, with 8 rows of seed per bed

Spacing: *Determinate:* 1 m between the rows and 30 cm within the row
Indeterminate: 1-1.2 m between the rows and 30-45 cm within the row

Planting time: Best period is March to November, except in frost sensitive areas in the Highveld, where average rainfall does not exceed 1000 mm. Winter production possible in the warm winter in the Lowveld. Prices are high during the rainy season but the incidence of diseases and insect pests are very high. Transplant after 6-8 weeks in the nursery. Tomatoes can be transplanted deeper than the original soil mark level. Seedling trays give the best crop since it suffers less from transplant shock

Cultural practices: For all indeterminate varieties it is best to stake or trellis the plants, so as to get the best quality and yield. Removing side branches to leave only one or two improves fruit size, quality and facilitates spraying and harvesting. Determinate varieties can also be trellised if the farmer is aiming for high quality, but the material required is less than for the indeterminate types

Trellising/Staking methods:

- Poles
- Strong poles and 2 or 3 horizontal wires
- Strong poles, 1 top horizontal wire and strings to suspend the plants on the wire. Length of poles 1.5 m, buried 0.30 m

Growth period: Tomatoes can last a total of 6 months from sowing to harvesting, depending on cultivar, management and growing conditions

Crop rotation: Crop rotation is very important, if not carried out the yields and quality are lowered and pests and disease incidence will increase. Tomatoes are very sensitive to nematodes and soil-borne diseases. Grow a crop once in 3-4 years in an area that had no other *Solanaceous* crops like paprika, potato and eggplants

Fertilizers: *Basal application:* 600-1000 kg of Compound S or Compound D applied per station
Top dressing: 100 kg/ha of AN plus 100 kg/ha Muriate of Potash applied three times, starting at the first fruit formation when they are about a marble size. Repeat after every three weeks

Harvesting: Harvest starts 4 months after transplanting

Expected yield: 30 tons/ha or more, depending on the cultivar and management

Pests:

- Red Spider Mite: Small reddish mites on the underside of the leaves, sucking the plant sap
Symptoms: Curled leaves, with silver spots and the plants look yellowish
Control: Spray Metasystox 25 EC, at 10 ml/10 litres of water, when first insects appear

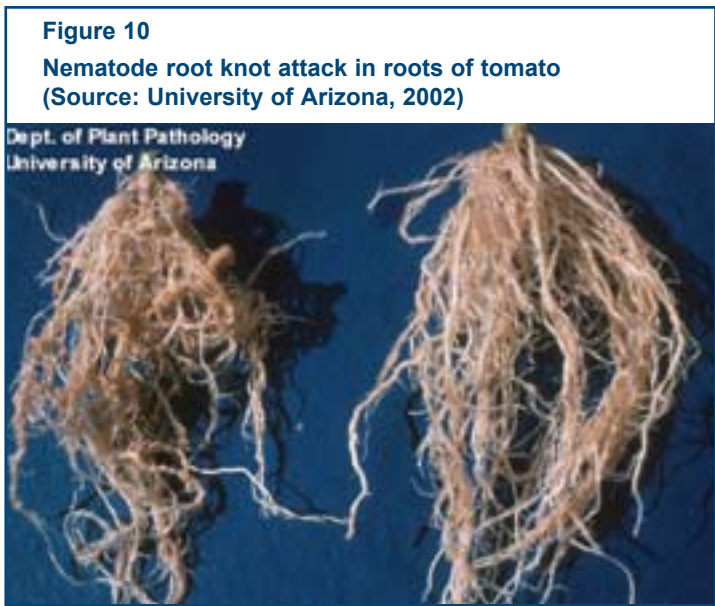

- Thrips: *Symptoms:* Silverish mottling of the leaves
Control: Spray Malathion 50 WP, at 10 g/10 litres of water, when first observed
 - Nematodes: *Symptoms:* Individual plants here and there in the field look stunted and knots and malformed roots
Control: Field treatment difficult and expensive. To use a 4-year rotation with non-sensitive crops
- Diseases:
- Late Blight
Phytophthora sp.: One of the most devastating diseases of tomato, enhanced by high relative humidity (>70%) and day temperatures between 22-25°C
Symptoms: Brown necrotic spots on the leaves starting from the top of the leaves; on the underside the leaves are covered with a white mycelium; brown to black spots on the stem and fruit, as if attacked by frost. The disease spreads very fast within a week
Control: Is usually late, but remove all infected branches and spray with Bravo 500, Milraz 76 WP or Dithane M45, at 20 g/10 litres of water, alternating with Ridomil MZ 72, at 35 g/10 litres of water, routine spraying is advised
 - Early Blight
Alternaria solani: Conditions which are wet, with high relative humidity and temperatures 24-28°C
Symptoms: On young plants in the seedbed are long, zoned spots on the lower stem. On the leaves brown zoned spots surrounded by a yellow halo. It also can attack the stems and fruits
Control: Same as for Late Blight
 - Wilts: Can be caused by several micro-organisms: *Fusarium oxysporum* (Figure 2a), takes 2 weeks to develop, *Rhizoctonia solani*, takes less than a week to develop, and *Verticillium dahliae* (Figure 2b)
Symptoms: Observed when one cuts through the stem: the vascular bundles are brown. One side of the plant dies
Control: Heat treatment of seed as well as dipping the seedlings in a Thiram solution at transplanting
 - Bacterial Canker: Caused by *Corynebacterium sp.*
Symptoms: Seen when the vascular system is observed: it is brown. A cut stem put in water will produce a milky ooze out of the cut end
Control: No control available, except hygiene and heat-treating the seeds
 - Leaf Spot: Starts 1 week before flowering
Symptoms: Necrotic spots on the leaves, the inner part is whitish
Control: Routine spray Dithane M45, at 25 g/10 litres of water, or Copper Oxychloride 80%, at 50 g/10 litres of water.
 - Mosaic viruses: *Symptoms:* Stunted plants, with curled leaves, light green in colour, flowers dropping and brown spots on the fruit
Control: Spray against the insects that spread the virus vectors, like white fly (*Bemisia tabaci*). Spray Cymbush 20 EC, at 50 ml/10 litres of water, or Metasystox 25 EC, at 10 ml/10 litres of water, or Parathion or Malathion and or Decis routine spray recommended

7.16. Watermelon

Scientific name:	<i>Citrullus lanatus</i>	
Family:	<i>Cucurbitaceae</i>	
Cultivars:	Charleston Grey and Congo, as well as many farmer varieties	
Soil:	Watermelons grow well in well-drained soils. They are very sensitive to waterlogging. Optimum pH is 5.5-6.5	
Climate:	Watermelons require higher heat than pumpkins, squash or cucumber. A hot, dry season is best. Wet summers can cause a lot of leaf disease. Areas below 1 200 m above sea level	
Seed amount:	3-5 kg/ha	
Spacing:	When using the furrow method: 2.5-3 m between the rows and 2.5-3 m within the row. Beds: 1.2 m wide with furrows 0.50-0.60 m, plants spaced 2.5-3 m	
Planting time:	Early production seeds can be sown in July-August	
Growth period:	4-5 months	
Fertilizers:	<i>Basal application:</i> 600 kg/ha of Compound D <i>Top dressing:</i> 100 kg/ha of AN after the first fruit setting and another 3 weeks later	
Harvesting:	Determining the maturity of watermelons can be difficult. Harvest with the stalk attached, when the green colour starts to turn yellow. Mature watermelons give a dull sound when tapped whereas immature give a metallic sound. Others use the stalk that attaches the fruit: when it starts to dry the fruit can be picked	
Expected yield:	9-11 tons/ha	
Pests:	<ul style="list-style-type: none"> • Root-knot nematode: <i>Symptoms:</i> Swollen roots as well as a stunted plant <i>Control:</i> Observe a 4-year rotation, avoiding the Solanaceae family (tomato, potato, paprika, etc.) • Aphids: Transmits mosaic virus <i>Symptoms:</i> Poorly elongating vine with curled leaves with aphids <i>Control:</i> Spray Dimethoate 40 EC, at 7.5 ml/10 litres of water, when observed on plants • Red Spider Mite: <i>Symptoms:</i> Small reddish insects on the underside of the leaves, causing leaves to loose colour curling and drying of the leaves <i>Control:</i> Spray Nuvacron 40, at 50 ml/10 litres of water, when observed on the plants 	
Diseases:	<ul style="list-style-type: none"> • <i>Fusarium</i> wilt: Soil-borne disease, takes about 2 weeks to develop <i>Symptoms:</i> Leaves start wilting followed by leaf necrosis of the older leaves <i>Control:</i> Dust seed with Thiram and use resistant cultivars • Anthracnose: Appears in wet weather conditions <i>Symptoms:</i> Black spots on the leaves, leaf stalks and stem as well as sunken lesions on the fruits; spores on mycelium visible <i>Control:</i> Routine spray Dithane M45, at 20 g/10 litres of water • Powdery Mildew: <i>Symptoms:</i> White powdery spots on the leaves; brown colouring of the leaves from the edge <i>Control:</i> Use systemic fungicides, for example Bavistin at 5 g/10 litres of water, once a week • Downy Mildew: <i>Symptoms:</i> Circular brown spots on the leaves with a yellowish halo; in advanced stages the attack looks like frost damage <i>Control:</i> Use Ridomil MZ 72 WP, at 25 g/10 litres of water, once a week or use Copper Oxychloride 85% WP, at 40 g/10 litres of water, once a week • Cucumber mosaic virus: <i>Symptoms:</i> Chlorosis of the leaves <i>Control:</i> Control the vector, which are usually aphids. Rogue out and destroy all infected plants 	

Figure 12
***Fusarium* on watermelon leaves (Source: University of Florida, 2000)**



Chapter 8

Agronomic aspects of fruit crops

In the sections below the agronomic aspects of the most important fruit crops in the sub-region are given. Again, the information refers to the climatic conditions prevailing in Zimbabwe (Chapter 1) and should be adapted for the other countries if the conditions are different. For information on crop water and irrigation requirements, the reader is referred to Module 4. Below, chemical products for

treatment of pests and diseases are given. It should be noted, however, that different control methods are possible as explained in Chapter 4. Integrated Production and Pest Management (IPPM) is becoming more and more successful in the sub-region and its application, wherever possible, is highly recommended (Chapter 5).

8.1. Apple and pear (pome fruits)

Scientific name: *Malus domestica* and *Pyrus communis*

Family: *Rosaceae*

Cultivars: Low Chill Apple Cultivars: Annah, Maayan, Michal, Ellah, Goldjon and Mutsu. Ellah and Annah act as pollinators
High Chill Apple Cultivars: Golden Delicious, Granny Smith, Starking, Marjorie Pie
Pear Cultivars: Hood, Wilder, William Mild Winter, Pineapple, Cares and LeConte. Hood and Pineapple require pollinators

Soil: Deep and well-drained soils are the best, with a pH of 5.0-5.5. They must contain high organic matter that can be amended by addition of compost or kraal manure

Climate: Pome fruits are indigenous to cool temperate conditions. They are dormant in winter and drop their leaves, and begin to grow again when it gets warm in spring. They require a cold winter to enable them to break buds and produce leaves, flowers and fruits. Most of Africa does not have winter temperatures that are low enough to grow pome fruits. In Zimbabwe pome fruits can only be grown in cooler Highveld areas that get frost in winter. The cold period required is called the chilling requirement, which refers to both the number of hours of cold and the temperature. Different pome fruit cultivars have different chilling requirements. There are low-chilling requiring cultivars that can be grown in Zimbabwe in the Highveld

Orchard layout: Establish pome fruits in the coolest part of the land. South-facing slopes are cooler than slopes that face in other directions. Most apple and pear varieties are self-sterile and will therefore need a different variety for cross-pollination. Preferably, varieties which flower at the same time should be planted

Soil preparation: Dig planting holes of 0.75 m x 0.75 m. Pile soil on one side of the hole with the topsoil on a separate heap from the subsoil. Mix topsoil with compost/manure and basal fertilizer and reserve subsoil for making basins

Tree spacing: 5 m between the rows and 5 m within the row (= 5 m x 5 m between the plants)

Planting trees: The best time for planting is during the dormant season (late June to mid August). The trees are planted bare root with no soil covering the roots. Drying of the roots should be avoided by covering the plants or roots with a moist sacking between uprooting from the nursery and planting. Trees should be planted to the same depth as they were in the nursery. Cut back trees to a height of about 60-75 cm from the ground

Fertilizers: Year 1: Either 750 g of Compound C per planting hole + one 20 litre bucket of compost or 500 g SSP + 300 g KCL. Top dress with 200 g/tree of AN about 6 weeks after planting
Years 2 and 3: 200 g/tree of AN in mid August and 100 g/tree in mid November
Year 4 and subsequent: 360 g/tree of Compound J in August, December and March-April

Pruning:

- At planting: Cut back trees to about 60-75 cm from the ground. During the first growing season, remove all suckers arising from below the graft union. This is best done when the shoots are still small (when they can be rubbed off with the fingers). Removal of larger shoots may result in wounds that serve as entry points for disease-causing organisms
- 1st winter after planting: Select 3-4 scaffold (main) branches, evenly spaced around the main trunk. These are the main branches and will be maintained throughout the productive life of the tree. If trees are to be trained to the centre leader from the top, most shoots should be trained vertically. The other common training system is the vase-shaped (or open centre, which means no middle shoot). Any diseased, damaged or dead wood should be removed (care being taken to keep pruning to the necessary minimum, unless trees are weak and small). Hard pruning during the early years will delay cropping of the trees

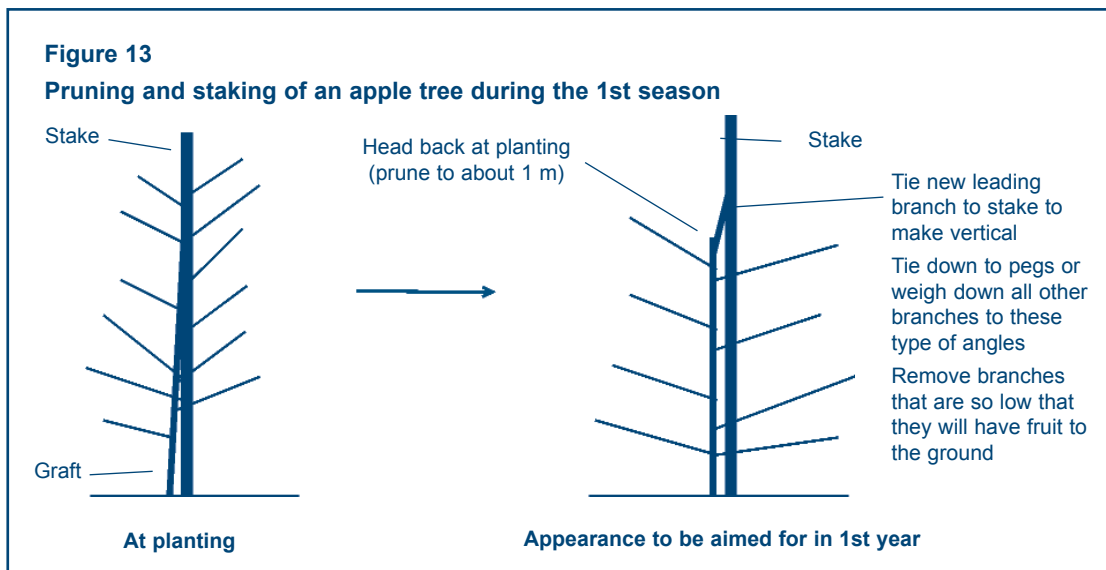

- 2nd winter after planting: On cropping trees, the objective of pruning is to maintain a balance between vegetative growth and fruiting. Dead, diseased and damaged wood should also be cut out. All water shoots are cut out cleanly at their point of origin (thinning out)

Types of pruning cuts:

- Thinning cut: Involves removal of an entire branch by cutting cleanly (flush with the trunk) from its point of origin. The result is a more open spreading canopy. This system is more suited to pruning vigorous dense trees
- Heading cut: Involves cutting back a shoot immediately above a bud. This will stimulate growth of the remaining buds into a compact canopy

Fruit thinning: Do not allow the trees to bear fruit before the 4th year after planting. Remove all flowers during the first 3 years while building a robust canopy. This is required in order to improve fruit size and remove misshapen fruits. The best time of thinning is 2-4 weeks after full bloom and should be completed 30-40 days after full bloom. 2-3 fruits per cluster should be left

Harvesting:

- Picking: It is important to harvest apples at the right time. Apples should be sweet and not floury or starchy. If picked too early or too late, they will not store well and will be of poor quality. Pears, on the other hand, must be mature before picking, but will never ripen until after picking. Avoid bruising the fruits at picking, use bags or basket to put the fruit in during picking. Picked fruits should be placed in shade and stored in a cool place
- Appearance of fruit: The colour of the cultivar must be fully developed. The pips or seeds of the fruit should be light brown or brown. If the seeds are white, it is too early to harvest the fruit. Once the seeds become too dark brown it is too late to harvest

Pests:

- Aphids: They are most notable on the younger shoots
Symptoms: Appearance of ants and distorted leaves at growing tips
Control: Apply Dimethoate, at 10 ml/10 litres of water, or Malathion 25 WP, at 20 g/10 litres of water
- Codling moths: *Symptoms:* The larvae tunnels into the fruit are filled with crumbly brown excrement. The larva is pale pink, with a brown head. The adult moth has grey front wings with brown markings across them and bright bronze markings on the edges
Control: Spray with Lebaycid WP, at 10 g/10 litres of water, when 75% of flower petals have dropped
- Fruit flies: *Symptoms:* Fruit flies lay their eggs in the fruit as it grows. The larvae feed on the fruit when they come out of the egg
Control: Spray a mixture of Malathion + sugar, at 10 + 60 g/10 litres of water, in large drops. The sugar attracts the insects to the poison
- Scale insects: Pernicious scale is the most serious
Symptoms: Dead branches starting from the growing tips, rough greyish bark
Control: Prune and burn infected branches. Spray Parathion or mineral oil after drop and again 4 weeks later

Disease/disorder:

- Powdery Mildew: *Symptoms:* White mould that grows on leaves and shoots, causing reduced growth
Control: Prune and burn infected shoots and then spray fungicides like Morestan 25% WP, at 4 g/10 litres of water, once a week until middle of December

- Scab: *Symptoms:* Leaves and fruit develop faint olive green spots that gradually turn black
Control: Spray Dithane M45, at 15 g/10 litres of water, every seven days until 30 days after full bloom
- Bitter-pit: This is physiological disorder, usually associated with Calcium deficiency
Symptoms: Sunken dark spots on the fruit surface and small patches of dry brown tissue within the flesh
Control: Adequate irrigation (avoid water stress), avoid excessive nitrogen and apply foliar sprays of Calcium nitrate around October-November
- Delayed foliation: A result of insufficient winter chilling
Symptoms: Erratic and delayed bud burst and a prolonged bud-break period. Some buds fail to open altogether, leaving long bare branches sometimes with die back
Control: Select the coldest site, use dormancy breaking chemicals, for example DNOC, Dormex, Thiourea + Potassium Nitrate and plant well-adapted cultivars

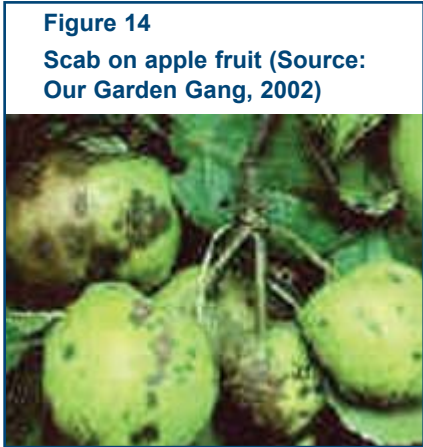

8.2. Avocado pear

Scientific name: *Persea americana*

Family: *Lauraceae*

Cultivars: The selection of cultivars must be based on their suitability for the export market. A cultivar should have a long storage life, travel well and be of acceptable quality. The maturity period of the cultivars must have a spread to cover the most suitable export season and give the longest possible season on the local market. The trees must be regular bearers, giving commercial crops. The following four cultivars are recommended:

Fuerte: ripening period April to August

Pinkerton: ripening period August to October

Hass: ripening period September to November

Ryan: ripening period October to January

Soil: Deep, well-drained alluvial soils with a slightly acid pH. On heavier soils, die back due to phytophthora rot can be severe

Climate: Being a sub-tropical fruit, it requires frost-free areas. The upper limit for production is 1 100 m

Orchard layout: If the orchard is planted on a slope, it is advisable to plant the trees on the contour lines. Grass waterways should be selected to take the surplus flow of water during heavy rains. If planting is done on the flat, the trees may be laid out on the square system

Tree spacing: To use land to maximum advantage and so obtain the highest and fastest return possible on capital, close initial spacing with tree pruning or removal 10-12 years later should be carried out, otherwise there will be significantly decreasing yield due to mutual shading. This can be indicated by large numbers of 'cukes' (seedless cucumber-shaped fruit) which are formed due to overcrowding. Fuerte, which is strong grower and forms a spreading tree, requires a wider spacing than the upright Hass, Pinkerton or Ryan. Spacing between rows should be 9-12 m

Planting trees: The best time to plant out trees is September/October. It is best to transplant towards the beginning of the rainy season in order to reduce initial irrigation costs and give the trees a long warm season to become well established. There is no need to dig a large hole for the young tree. The depth of the hole should be the same depth or slightly shallower than the container. The width of the hole should be about 20 cm wider than the pot so as to be able to manipulate the plant in the hole and remove the pot by cutting one side with a knife and pulling it from the ball of the soil. The soil for filling the hole should be mixed with a handful and a half of SSP

Table 16

Recommended spacing for avocados (Source: Cassidy, undated)

Cultivar	Initial spacing in the row (m)	Final spacing (m)	Approximate number of trees per ha
Fuerte	5.5-6	11-12 x 10	181-167
Hass	4.5	9 x 9	222
Pinkerton	4.5	9 x 9	222
Ryan	4.5	9 x 9	222

Fertilizers: Fertilizer should be spread over the entire root area, about 30 cm from the stem to about 45 cm outside the drip area. Since the roots of avocados are shallow and very sensitive, each application of fertilizer should be followed by a light irrigation. Quantities of fertilizer used will vary with tree size, cultivar and soil conditions. The cultivar Hass generally requires almost double that required for other cultivars. Foliar analysis before flower burst and also in March will aid in fixing the fertilizer programme. The fertilizer application for the first year is given in six dressings during the summer season. After that, nitrogen and potassium are applied in three equal applications in July, December and April. The phosphate is applied in December. It is not advisable to apply heavy nitrogenous fertilizers closer than six weeks before or after blossoming, as fruit yield can be impaired. Since most soils are naturally low in zinc or the zinc is not available, this element must be applied every year. Spray trees annually to drip with a 0,2% solution of zinc oxide

Table 17**Quantity of fertilizer in grams per year per avocado tree, according to age (Source: Cassidy, undated)**

Age (Years)	Ammonium Nitrate (11.3% P)	Super-Phosphate (60% K ₂ O)	Potassium Chloride
1	150	-	50
2	225	200	150
3	375	250	200
4-5	450	300	350
6-7	750	350	450
8-9	900	400	700
10-12	1125	550	900
Maximum	1750	750	1400

Method to determine maturity:

- **Water content:** The maturity of avocados is related approximately to the moisture content. The fruit is normally ready to be picked when it has a moisture content of 80% or less. The moisture content of the fruit is easy to determine. A random sample of at least ten fruits is taken, the avocado is bisected lengthwise and the seedless half is peeled on one side. A portion of this side is now grated with a reasonably fine household grater. This is repeated with the other fruits and a representative sample of exactly 100 grams is obtained. The sample is spread in an open dish and dried in an oven at low temperature for about 6 hours. Since the initial sample was exactly 100 grams, the weight loss will give the moisture percentage. If sample weight is more than 80 grams, the fruits should not be picked
- **Ripening time:** Once the season is well under way, maturity problems become less severe and the fruit can be harvested according to size alone. After moisture determination, the following procedure may be applied. Pick a representative sample of fruits, which in one's opinion has attained the average size. Store this fruit at room temperature until it ripens. An avocado is ripe when it yields slightly to light pressure applied on the surface. If the samples ripen within 8-10 days and show no sign of shriveling, the fruit may be considered mature. If the fruit takes more than 10-12 days to ripen, the ripeness test may be repeated in a week
- **Appearance of fruit:** Purple or dark-coloured cultivars usually turn from green to dark colour at maturity. Green cultivars are mature when a yellowish tint appears on the stem, close to the fruit. The fruit usually has a smooth peel, particularly on the part furthest from the stem
- **Appearance of seed membrane:** Cut open the fruit to see the membrane enclosing the seed. On immature fruit, the membrane is fleshy and its colour varies from a yellowish white to light brown. Mature fruits have a membrane that is usually thin and its colour varies from brown to dark brown

Harvesting:

- **Start:** Harvesting starts 4 years after planting for grafted trees. Handle fruit carefully; any scratches on the fruit are entry points for post-harvest diseases
- **Picking** While the fruit is on the tree, it remains hard, it becomes soft and edible only after picking. Mature fruit ripens evenly. The edible part acquires a smooth, buttery texture and the peel shows no sign of shriveling. Immature fruit that is picked too early will not ripen properly and the skin will eventually become shriveled

Storage:

The correct storage temperature after harvest will vary with the cultivar. Sensitive types should not be stored at less than 13°C; tolerant ones can be stored at as low as 4.4°C. Storage temperatures for Hass and Fuerte have been experimentally determined at 7.2°C. Chilling injury will be seen as a greyish brown discolouration in the flesh and scalding and pitting of the skin. Failure to soften properly after removal from storage is also a symptom. Regardless of storage temperatures, a relative humidity of 85-90% should be maintained in the cooler

Expected yield:	Yields may vary from 4 to 11 t/ha per year, depending mainly upon the age of the avocado tree	
Diseases:	• Phytophthora root rot:	Use root rot tolerant rootstocks, like Duke 7, G.22 and G.755
	• Sun Blotch virus:	Transmitted through infected seed <i>Symptoms:</i> Stunted growth, yellow depressed areas at the stem end of fruit <i>Control:</i> Difficult to control besides uprooting the tree. Plant clean material
	• Anthracnose:	Caused by the fungus <i>Colletotricum gloesporioides</i> . Is particularly severe on Fuerte and often causes losses as high as 70% during wet seasons <i>Symptoms:</i> Infection occurs from fruit set to maturity during the rainy periods in summer. After infection, the fungus remains latent in the skin and symptoms usually develop as brown to black lesions at maturity. The fungus can progress into the flesh of the avocado fruit, producing a greenish-black decay, which eventually may involve a large portion of the fruit <i>Control:</i>
	• Post-harvest Diplodia stem-end rot (<i>Diplodia natalensis</i>):	Resulting from latent or quiescent infections of fruits in the orchard. Common, especially in humid growing areas <i>Symptoms:</i> After harvest, the fungus colonizes first the stem and then the flesh near the stem. Infection of the fruit stem occurs when temperature and moisture are favourable during fruit development. Temperature management is important in delaying the development of rot. Diplodia rot does not develop below 6°C <i>Control:</i> A post-harvest dip of Thiabendazole largely eliminates Diplodia rot

8.3. Banana

Scientific name:	<i>Musa cavendish</i>	
Family:	<i>Musaceae</i>	
Cultivars:	Giant Williams, Dwarf Cavendish	
Soil:	Deep soils, at least 1 m. Sandy loam soils are the best, but bananas can grow on a wide range of well-drained soils. The pH should be 5.5-6.5. The soil should be free from nematodes	
Climate:	The banana has a high heat and water requirement. The best temperature range is between 20 and 30°C, with evenly distributed irrigation or rainfall. It is very sensitive to frost attack. Cold weather negatively affects the bunch development	
Planting material:	Bananas are very sensitive to frost. The sword suckers are the best planting material, they must be as uniform as possible. Remove all roots before planting. Select planting suckers from a healthy orchard. In altitudes less than 1000 m above sea level, select suckers of Dwarf Cavendish and plant between July and November. The bunches will emerge between February and April and are harvested in July-October. Suckers selected between December and March produce bunches of poor quality	
Tree spacing:	2.4 m x 2.7 m or 4.0 x 2.0 m	
Cultural practices:	• Weeds:	Keep plantation free of weeds and avoid deep weeding, which damages the shallow root system
	• Desuckering:	Growth of suckers is greatest in August to April and low during winter. This is the period to select the suckers, which must be sword suckers (young suckers on which the first narrow leaves have begun to unfold) since they have a stronger attachment to the rhizome. Water suckers, which are small suckers growing around the main shoot, are unsuitable for followers and should be removed
	• Propping:	Wind, old age and poor sucker selection may result in falling. Use single wooden stakes and prop against the throat of the plant. Williams is very prone to wind damage due to its height and heavy bunch weight.
	• Trimming of leaves and bunches:	Removal of dead leaves helps to reduce diseases. Trimming is best done in April and August. Avoid winter trimming. Withered floral remnants at the end of the banana fingers are removed, which improves appearance and reduces spread of the cigar-end rot infection. The bell is removed to increase average finger weight
	• Bunch covers:	Blue polythene bunch covers, open on both sides. Loosely tied above the first hand of the bunch and hanging about 15 cm below the lowest hand, they protect the fruit from hail damage. To control pests, spray the bunches before covering. Apply bunch covers at the onset of the rains and remove them three weeks from maturity
	• Windbreaks:	In areas where wind is a problem, windbreaks will minimize losses due to wind damage and leaf tearing. Use wind breaks available within your area
Crop duration:	About 5 years	

Fertilizers:	Manure: 10-20 tons/ha before planting Nitrogen: 400-700 kg/ha of AN, add as a top dressing in four equal amounts in January, March, September and November Potassium: 250-750 kg/ha of Muriate of Potash, apply at the same time as AN Phosphate: 200-350 kg/ha of SSP, apply and incorporate before establishment. Apply again at 150-300 kg/ha each year in August and September Lime: Apply 0.5-2 tons/ha of lime when the pH is below 5.5. pH range should be 5.5-6.5
Harvesting:	Bunches are harvested when the fruit is about three-quarters full and the fruit starts to change colour from green to yellow. Packing bunches in boxes padded with a thick layer of foam rubber minimizes bruising
Expected yield:	50 tons/ha per year
Pests:	<ul style="list-style-type: none"> Burrowing nematode (<i>Radopholus similis</i>): <i>Symptoms</i>: Causes toppling disease that destroys the plant roots, resulting in plants falling over. <i>Control</i>: Fenamiphos, a systemic nematicide, controls the burrowing nematode. Apply soon after outbreak. Practice rotations as well.
Diseases:	<ul style="list-style-type: none"> Cigar-end rot: This fungal disease is caused by <i>Verticillium theobromae</i>. <i>Symptoms</i>: The rotted portion of the banana finger is dry and tends to adhere to fruits. Appears similar to the ash of a cigar. <i>Control</i>: Remove the pistil and perianth parts of the flower 8-11 days after bunch emergence

8.4. Citrus spp.

Scientific name:	<i>Citrus spp.</i>
	<ul style="list-style-type: none"> Sweet orange: <i>Citrus sinensis</i> Lemon: <i>Citrus limon</i> Grapefruit: <i>Citrus paradisi</i> Naartje/Mandarin: <i>Citrus reticulata</i>
Family:	<i>Rutaceae</i>
Cultivars:	Tables 18, 19 and 20 summarize the cultivars, rootstocks, most suitable advised spacing, as well as the maturity dates for high, middle and low altitude areas of southern Africa, with the examples taken from the Zimbabwe experience

Table 18

Cultivar, selection, commercial rootstocks, spacing and maturity dates for citrus in the high altitude areas (Source: Barrie, 1996)

Cultivar	Selection	Rootstock	Spacing (m)	Maturity dates
Navels	Palmer R	CC,TC	6.0 x 2.5	Mid-May - Mid-June
	Bahianinha R	CC,TC	6.0 x 2.5	Late June - Mid-July
	Royal Late R	CC,TC	6.0 x 2.5	
Valencia	Mid knight P	CC,TC, SC	6.0 x 2.5	Mid-August - Late September
	Delta P	CC,TC, SC	6.5 x 2.75	Mid-July - Mid-August
Easy Peelers	Nules R	CC,TC	5.5 x 2.5	Mid-April - Late May
	Nova	CC,TC	5.5 x 2.5	Early April - Early May
	Thoro Temple	CC,TC	5.5 x 2.5	June
Lemons	Eureka R	RL	6.5 x 2.75	March - April, June
	Lisbon R	RL,TC, SC	6.5 x 2.75	April - May

Table 19

Cultivar, selection, commercial rootstock, spacing and maturity dates for citrus in the middle altitude areas (Source: Barrie, 1996)

Cultivar	Selection	Rootstock	Spacing (m)	Maturity dates
Navels	Palmer R	TC	6.5 x 3.0	Late April - Mid-May
	Bahianinha R	CC,TC	6.0 x 2.5	Early May - Early June
	Royal Late R	CC,TC, SC	6.0 x 2.5	Mid-June - Late July
Valencia	Mid knight P	CC,TC, SC	6.0 x 2.5	Mid-August - Late September
	Delta P	CC,TC, SC	6.5 x 2.75	Mid-July - Mid-August
	Late R	TC, CC, SC, RL	6.5 x 3.0	Late August
Lemons	Eureka R	RL	6.5 x 3.0	March - June
	Lisbon R	RL,TC, SC	6.5 x 3.0	April - May

Table 20
Cultivar, selection, commercial rootstock, spacing and maturity dates for citrus in the low altitude areas (Source: Barrie, 1996)

Cultivar	Selection	Rootstock	Spacing (m)	Maturity dates
Valencia	Delta P	CC,TC, SC	7.0 x 3.0	Mid-July
	Late R	CC,TC, SC, RL	7.0 x 3.0	August
	DuRoi P	CC,TC, SC, RL	7.0 x 3.0	August
Grapefruit	Marsh P	CC,TC, SC	7.0 x 3.0	Late April - May
	Star Ruby P	CC,TC, SC	6.5 x 2.5	Late April - May
Midseason	Tomango M	CC,TC	7.0 x 3.0	Late May - June
Lemons	Eureka R	RL	7.0 x 3.5	March - June
	Lisbon R	RL,TC, SC	7.0 x 3.5	April - May

Note on abbreviations:

Selection: R = Recommended; P = Potential; M = Marginal

Rootstock: CC = Carrizo Citrange; TC = Troyer Citrange; RL = Rough Lemon; SC = Swingle Citrumelo

Always buy citrus plants from a reputable nursery, which supply clean disease-free plants

Soil: Deep and well-drained soils are best suitable for citrus production. pH 5.5-6.0. The best soils are sandy to sandy loams. In case of heavy soil, plant the trees on ridges

Climate: The climate interacts with the fruit quality in a number of ways. Some areas are more suitable to navel oranges than grapefruits. Different areas are more suited to some selections of citrus than others. In Zimbabwe, citrus can be grown in Lowveld, Middleveld and Highveld areas. Where winds are strong, use windbreaks

Planting Time: August to November

Young trees

Fertilization: For the first 3 years apply 16 grams of AN per tree after every 3 weeks. During the active growing months of August to March apply 30 grams per tree every 2 weeks. During the active growing period apply a foliar application every 4-6 weeks of 150 g Urea, 20 g Zinc Oxide, 20 g Copper oxy chloride, 15 g Solubor (Boron) in 15 litres of water as a mixture or cocktail

Mulching: Mulching is advisable to avoid young trees drying out. Use organic materials like maize stover, keep away from contact with the stem and watch for ants

Sucker control: Remove all suckers below the graft union every week while they are still soft. Avoid doing so when they get tough, since removing them then may damage the bark

Pests:

- Orange dog: *Symptoms:* Caterpillars that eat the foliage
Control: By hand or spray Dipel or Biobit, or Carvaryl, at 20g/10 litres of water
- Thrips: *Symptoms:* Tiny insects that feed on new flush, resulting in distortion of the leaf
Control: They are controlled biologically by predatory mites. Careless application of chemicals will affect this. Spray a cover spray on leaves and fruits, at 20 g/10 litres of water. Adding sugar is essential because Tartar Emetic is a stomach poison. Use about 3 sprays per season October, November and December
- Psylla: *Symptoms:* Transmits Greening Disease and results in leaf deformation and eventual tree death. Psylla feeds only on the new flush, which in bearing trees usually occurs 3 times per year
Control: Scouting must be carried out thoroughly, treat when Psylla is detected. Apply Endosulfan WP at the rate recommended on the label. Stem treatment with Azodrin or Citrimet will also control Psylla
- Aphids: *Symptoms:* Presence of ants and curled leaves at growing tips with aphids
Control: Apply Pirimor, at 4 g/10 litres of water, when the insects are first seen
- Budmite: Can distort young growth
Symptoms: Distorted growth at young age
Control: Spray Tedion/Tetradifon on the leaves, at 20 ml/10 litres of water, when 20% of leaves are infested, or spray Neoron on the fruit, at 3 ml/10 litres in March
- Ants/termites: *Control:* In young orchards control with Chlorasol, at 400 ml/10 litres of water, or treat ant nests with 5 g Malathion 25% WP per hole, when they have been seen

- Red Scale: *Symptoms:* Small scale like insects that live on the stem twigs and leaf midribs on trees of all ages
Control: Spray mineral oil, keep the spray-mix well agitated all the time. Apply 3 sprays per year when crawlers have been observed
- Diseases:
- Phytophthora: Nursery trees should be free from this disease
Control: Control every 6 weeks during periods when growth is very active with Aliette stem paint as a preventative treatment

Bearing trees

Fertilization: Guidelines for bearing trees are given in Table 21 below.

Table 21

Fertilization guidelines for bearing trees in the absence of leaf and soil analysis, in grams/tree (Source: Dodhill Nursery, undated)

Tree age (Years)	Ammonium Nitrate (a)	Single Super Phosphate (b)	Muriate of Potash (c)	Agricultural Lime (d)
4	400	200	150	200
5	500	300	200	400
6	600	400	250	800
7	800	600	400	1200
8	1000	800	600	1400
9	1200	1000	800	1600
10	1400	1200	1000	1800
>10	1500	1500	1200	2000

Notes:

(a) Split Ammonium Nitrate (AN) into 4 equal dressings from last week of July to last week of August

(b) 1 application in August

(c) Split Muriate of Potash (MOP) into 2 equal dressings mid September and end September

(d) 1 application in November

- Harvesting:
- Picking: Fruit maturity is determined by the colour and by the acid content versus Total Soluble Solids (TSS) ratio. The citric acid and TSS (sugars) give the fruit its characteristic flavour. In general, if acids are low and sugars too high the fruit is insipid. If it is the other way round, the fruit is sour. Each type of fruit has a range of acceptable ratios that will indicate internal fruit maturity. Colour standards for different varieties exist and are used commercially. In general, fruit colour and internal maturity occur at the same time. When the fruit is mature, withhold water to harden the fruit against picking injuries such as Oleocellosis. Avoid picking fruits when they are still wet from dew. Pickers should cut their fingernails short and pick fruit with their palms not finger to avoid injuries to the rind
 - Packing: Fruit should be packed in small containers to minimize damage. Rough handling of fruit at this stage can affect quality and prices. Pack fruits into cartons for export after fruit has been washed, de-scaled, heat treated, waxed, polished, graded and sized

Storage: Store the fruits under shed and cool conditions, preferably in ventilated plastic pockets

Marketing: The quality of the fruit will determine the prices it will fetch on the market and which market will buy it. Fruit quality is composed of: fruit size, fruit colour, rind blemishes, rind thickness, juice percentage, acid versus TSS ratio and fruit toughness. A grower who produces high quality fruit standards will have the flexibility to sell the crop to all potential markets

- Pests:
- Red Scale: Red Scale is one of the most important pests of Citrus
Symptoms: Heavy infestations of Red Scale can cause fruit drop, leaf drop, die back of twigs, resulting in the eventual death of the tree
Control: For trees less than 3 years of age, control by use of mineral oil sprays applied at a concentration of 1.25%. Keep agitating the mixture and avoid spraying when temperatures are above 30°C. Apply after scouting when crawlers are observed
 - Ants: *Control:* Paint the stem regularly with Chlodasol, at 400 ml/10 litres of water, or treat ant nests with 5 g Malathion 25% WP per hole. Once trees are 3 years old, an ant-band should be fitted. Ant bands comprise 3 layers. The first layer is a strip of rough-woven fibrous material of about 10 cm wide. This should be wrapped one and half times round the tree. On top of this, apply 2 layers of 8 cm wide plastic. This should not touch the tree to avoid water being trapped underneath it. On top of the plastic, put a thin layer of

- ant-bar, a sticky material 25 mm wide with a flat-ended stick. This traps ants and stops them from going up into the tree canopy. Inspect the ant-bar once a month
- Thrips: *Symptoms:* Cause serious blemish to the rind of the fruit, thus downgrading the fruit. They also feed on young flush and cause severe distortion of the leaves, reducing yields
Control: Apply Tartar Emetic (Tratox or Thrivot) together with sugar as a coarse spray over the leaves and fruit, at 20 g/10 litres of water + 20 g sugar/10 litres of water. 3 sprays per season will be required
 - Mites on fruit: Rust mites, flat mites
Symptoms: Small scale-like insects that live on the stem twigs and leaf midribs on trees of all ages
Control: They should be controlled when 10% of the leaves are infested. Use Torque at the rate recommended on the label
 - Mites on leaf: Lowveld mites, Red mites, Bud mites. Lowveld mites and Red mites occur in winter
Symptoms: Distorted leaves and fruits
Control: Apply Tedium/Tetradifon, at 20 ml/10 litres of water, when 20% of the leaves are infested. Bud mites can be controlled by Neoron, at 3 ml/10 litres water in March
 - Grey mite: Attacks leaves and fruits
Symptoms: Distorted leaves and fruits
Control: Use Torque at the rate recommended on the label, when 10% of the leaves are infested
 - Psylla: Transmits a major citrus disease, called Citrus Greening, which may eventually cause death of the tree. Psylla feeds on new flush, which in bearing trees usually occurs 3 times per year
Symptoms: Distorted leaves
Control: After scouting, apply a foliar spray of Endosulfan WP at the rate recommended on the label
 - Aphids: *Symptoms:* Transmit Tristeza virus to Grapefruit, causing tree decline and death. High aphid infestation causes leaf distortion
Control: Apply Pirimor, at 4 g/10 litres of water
 - Mearly bug/
soft scale: These pests are well controlled biologically. Chemical control is often costly and ineffective. Concentrate on ant control
 - Fruit fly / False
Codling moth: *Symptoms:* These pests attack the ripening fruit. The stings act as entry points for infection, causing the fruit to go rotten and drop
Control: The major part of control is sanitation. Collect once a week all stung, rotten and dropped fruit and bury it 1 m deep. From March, trees should be baited weekly as an additional measure for fruit fly control. About 200 ml of a solution of Malathion 25% WP + sugar, 30g + 800 g/10 litres of water, or Protein Hydrolysate, at 40 g/10 litres of water, should be applied as a coarse spray to the top of every tree in every second row. The next week the trees that were not baited should be baited and so on

8.5. Grape

Scientific name: *Vitis vinifera*, *Vitis labrusca*

Family: *Vitaceae*

Cultivars: Cultivars are given in Table 22 below.

Table 22
List of table grape cultivars (Source: Parsons, undated)

Cultivars	Time of ripening	Vigour	Yield potential	Disease resistance
Golden City	Nov-Dec	Medium	Medium	Resistant to Anthracnose, Berry rot, Powdery Mildew
Seneca	Nov-Dec	Strong	Heavy	Fairly susceptible to diseases
Sultana	Jan-Mar	Strong	Medium	
Black Pirobella	Nov-Dec	Medium	High	Fairly resistant to Anthracnose and Powdery Mildew
Muska	Nov-Dec	Medium	Good	Fairly resistant to Anthracnose
Giant Isabella	Jan-Feb	Vigorous	Good	Resistant

- Soil:** Soils must be well-drained, with a pH of around 5.5
- Climate:** Summer rainfall areas do not provide ideal conditions for the production of grapes, due to higher prevalence of diseases, and reduction in heat and temperature due to overcast weather conditions. During periods when rains are delayed in December, high sugar content grapes may be harvested. The best conditions for the production of grapes are in areas where winters are cold and summers hot and dry with long sunny days. In Zimbabwe, as an example where longest days are shorter than those in many countries, it is not easy to grow grapes with high sugar content and good quality because of the short days and summer rains
- Land preparation:** The land should be deeply ploughed and all weeds should be removed. Dig square holes of 60 cm x 60 cm and 1 m deep. Place the topsoil and sub-soils separately. Add 500 g of SSP and well-decomposed manure or compost. Mix with the topsoil before filling, using topsoil first
- Tree spacing:** 3 m to 3.25 m between the rows and 1.5 m within the row
- Planting trees:** In summer rainfall areas, site rows so that the prevailing wind blows along them. This reduces the spread of diseases. Vines should be planted to the same depth as the nursery with the bud/graft union above ground after root trimming. Firm the soil after planting and apply some water as soon as possible. The plant population will be about 2 100-2 200 at a spacing of 3 m x 1.5 m
- Trellising:** In areas where it rains in summer, it is important to trellis grapevines for the following reasons:
- Robust support is provided to the vines and wind damage will be reduced
 - Air circulation is improved and the vines are able to dry out readily following rain, which reduces disease incidence.
 - Cultural operations like weeding, irrigation, pruning and harvesting are made easier
- The disadvantages of trellising are the direct cost and labour involved in tying the wires and the vines to the trellis
- **Fence trellis system:** Supporting poles are spaced 7-10 m apart, with intermediate supports at 2 m intervals. Three wires are secured to the supports, the lowest being 1 m above ground level, the second about 25-30 cm above the first and the third the same distance above the second (Figure 15). Vines are trained to the low wire and upper wire(s) used for support. Some bunches will be hidden, while others may be exposed to sun scorch and aeration is not very good. This is the cheapest form of trellising but can result in poor spray penetration

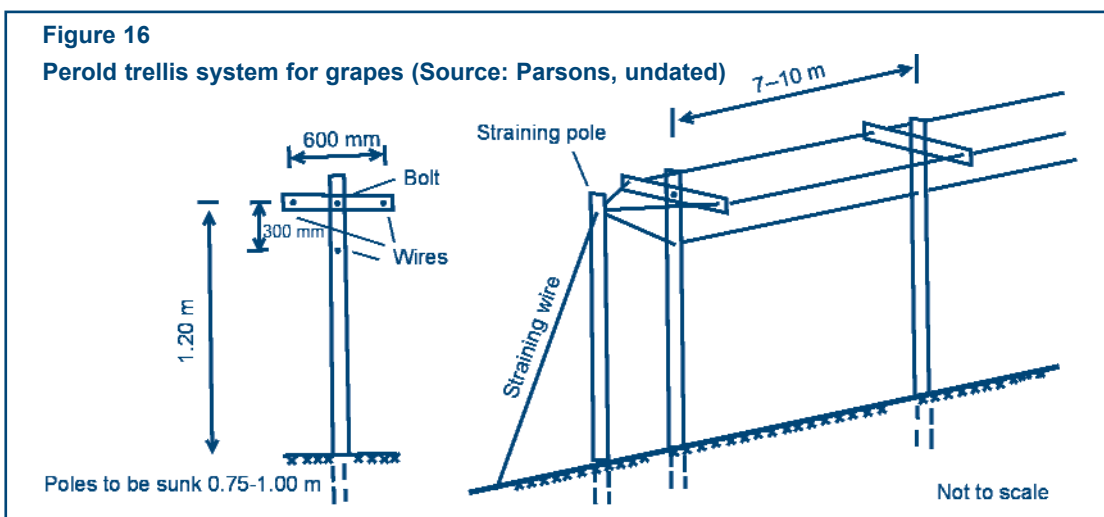
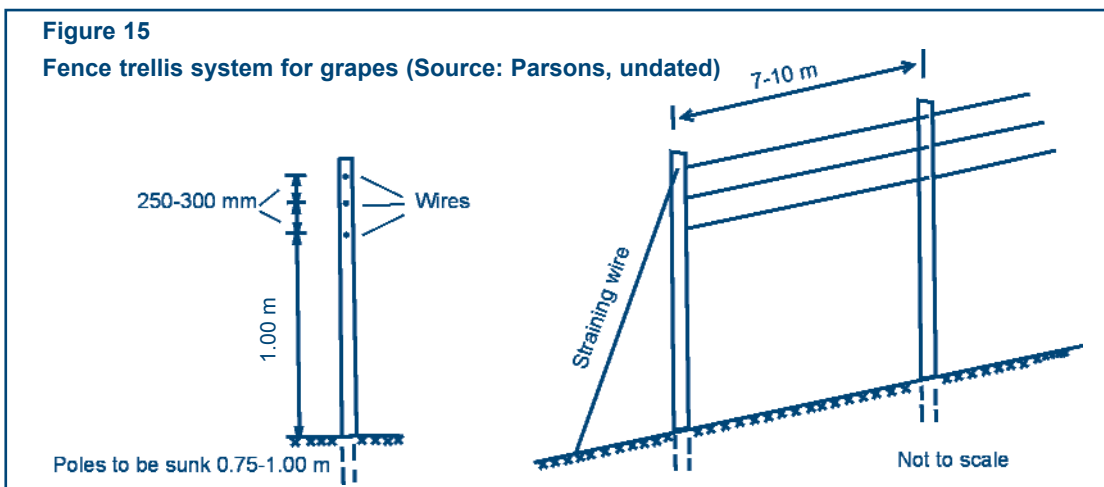

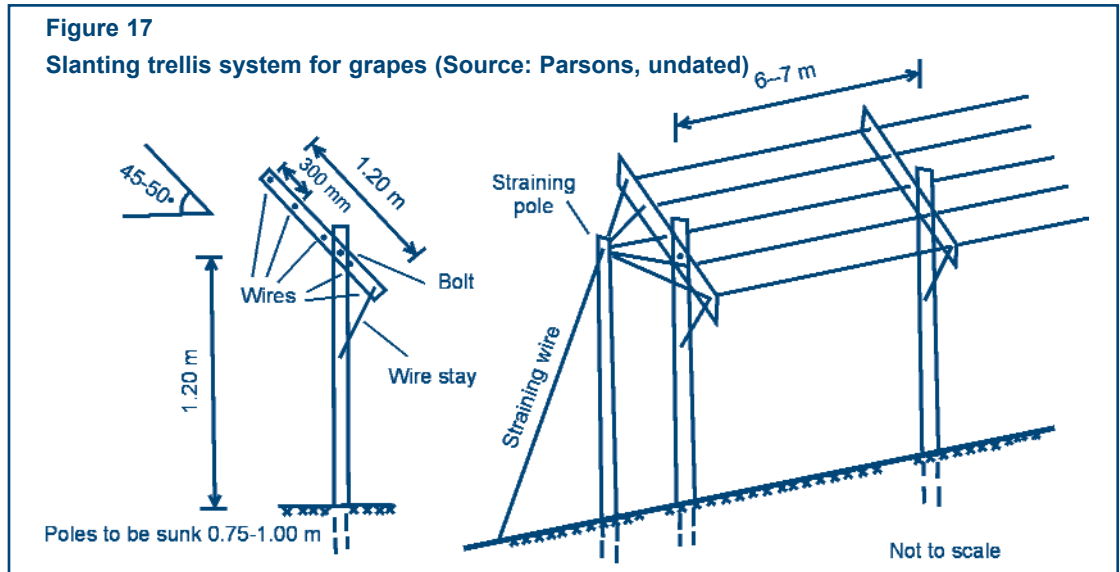

- **Perold and duplex trellis system:** A horizontal crosspiece of about 6 cm long is attached at its centre to the top of an upright 1.3 m above ground level and at right-angles to the direction of the row. Two wires are attached to the crosspiece, one at each end. A third wire is attached to the upright, 30 cm below the crosspiece (Figure 16). Vines are trained up to the low wire and the upper wires are to support the shoots. This system gives some protection against wind, allows a greater leaf surface to be exposed to sunlight, and protects fruits from sunburn. The system is best suitable for machine harvesting of grapes
- **Slanting trellis system:** The trellis is constructed as in Figure 17 below. If treated, gum-poles are used. They should be 12 cm in diameter for the end posts and 8-10 cm for the line posts and crosspieces. When attaching the wires, the lowest should be positioned and tightened first in one direction, then the highest wire in the opposite direction to give maximum tautness and preventing twisting of the framework. This is the system most commonly used on table grapes. It allows for a large leaf area to be exposed to sunlight, while providing good protection from sun scorch to bunches of grapes. This system allows light to penetrate to bunches enhancing fruit colouring. The bunches hang free, making thinning or picking easier. Disease control is good, as air circulation is plentiful and the spray cover effective. The sloping crosspiece of the trellis does not impede the movement of machinery between rows
- **Overhead trellis system:** This consists of a horizontal system of wires, about 2 m from the ground and supported on poles. The vines are trained up to the overhead wires enabling the bunches to hang freely.

Fertilizers: The fertilizer application programme is as shown in Table 23 below.

Table 23
Grapes fertilizer application programme (Source: Parsons, undated)

Period of application	Fertilizer application per vine (grams) *		
	AN	SSP	MOP
1. At planting, to each hole		500	30
2. For young vines	15		
Monthly top-dressing, August to March	15		
In July apply	15	30	30
3. For bearing vines: Three year old trees:			
In July apply	50	90	45
Six weeks after bud burst	50		
Post-harvest	25	90	45
4. Increase annually until maximum is reached at seven years, which is:			
In July apply	150	150	90
Six weeks after bud burst	150		
Post-harvest	75	150	90

* AN = Ammonium Nitrate; SSP = Single Super Phosphate; MOP = Muriate of Potash

- Correction of trace- Zinc:
 element deficiency: For best results pruning cuts should be soaked with a solution of 500 g Zinc Sulphate in 5 litres of water. Apply a foliar spray two or three weeks before blossoming containing: 50-100 g Zinc Sulphate plus 25-50 g slaked lime plus a wetter dissolved in 10 litres of water
 Boron:
 Solubor can be sprayed at 1 kilogram in 500 litres water, 4-6 weeks after bud burst, or apply fertilizer borate at the rate of 14-28 g per vine once a year where there is a deficiency and only every 3-4 years for maintenance applications
 Iron:
 Apply in the form of chelate organic iron, at 100 g per vine in the soil, or spray, at 10 g/10 litres of water
 Manganese:
 If manganese deficiency is detected, spray Manganese Sulphate, at 20-25 g/10 litres of water when shoots are 150-250 mm long. Avoid excess application of Manganese, otherwise toxicity will occur
- Cultural practices:
- Weeding: Weeds can be eliminated by ploughing prior to planting, followed by discing between rows and hand weeding
 - Mulching: Grass or straw mulch can be used to control weeds and conserve moisture
 - Training: Grapes grown in summer rainfall areas should be trained on trellises in the following ways (Figure 18.1-18.4):
 - After planting in the vineyard, the strongest shoot is cut back to two good buds, above the graft union for grafted trees (Figure 18.1)
 - Stake the strongest branch formed from the buds until it reaches the first horizontal wire, which is to support the first pair of arms. Remove all other side shoots
 - When the tip of the vine reaches the wire, the tip is pinched to encourage the buds below the pinch to grow out (Figure 18.2). The first two shoots arising below the wire are trained along the supporting wire in opposite directions, allowing all shoots growing on these arms (Figure 18.3). It is essential that the two arms should arise from below the wire and not have to be bent over from above. The arms and shoots that will grow can be pruned in winter (Figure 18.4)
 - When the vines fail to reach the wire in one season or are very weak they should be cut back to three or four buds and treated as younger vines from then on
 - Pruning: Winter is the main pruning time, while the vines are dormant. Figures 18.5 and 18.6 illustrate the general procedures of the pruning operations The reasons for pruning are:
 - To control vine growth, so that balance is maintained between vegetative and fruiting growth. Each vine can nourish and ripen successfully only a certain number of bunches. The quantity is dependent upon the age and vigour of the vine, the leaf surface area and the number of fertile buds
 - To remove old, diseased or damaged vines
 - To establish the shape of the vine wanted for the particular trellising system used and to enable cultural operations to be carried out without damaging the vine
- Maturity: Grapes must be mature when harvested, as they do not continue to ripen after being removed from the vine and must have an acceptable sugar to acid ratio. In general, the sugar levels increase as the grapes mature while the proportion of acid decreases. Sweetness varies with different cultivars. The time of harvest is determined by the change of colour and sugar levels in the berries
- Harvesting: Table grapes must be harvested by hand, removing from the bunch any unripe or damaged berries. Careful packing is important, handling each bunch only by its stem and keep them cool after harvesting
- Expected yields: 3rd year after planting: 0.5 kg/vine; 4th year after planting: 1.5 kg/vine; 5th year after planting: 3.5 kg/vine; 6th year after planting: 7.0 kg/vine. Multiplying these figures with the number of vines per ha (for example 2000 vines/ha) gives the annual yield per ha. Grape vines should give maximum yields 6-7 years after establishment, provided management is correct and no major setbacks are met, such as severe hailstorms, severe disease and pest attacks
- Pests:
- Ants and termites: Ants may be attracted to vines by the exudations from Mealy bugs and by the juice from damaged berries. Termites may actively damage vines by tunneling both in and underneath the plants and they often affect wooden trellising supports
Control: Apply Chlordane 30%, at 400 ml/10 litres of water, for both pests to the soil around the vines
 - Beetles: Chafer beetles and snout beetles are leaf-eating insects that cause considerable damage in a vineyard, usually early in the season. Both types of beetles feed during the night and return to the soil near the vines during the day
Symptoms: Lacerated leaves with reduced leaf area
Control: When the need arises apply Carbaryl 85%, at 12.5 g/10 litres of water, to the vines and to the soil around them late in the day. Vine shoots should not be allowed to touch the ground, as they provide access to plants by the beetles

Figure 18

Training and pruning of vines in which fruitful buds occur near base of the canes
(Source: Parsons, undated)

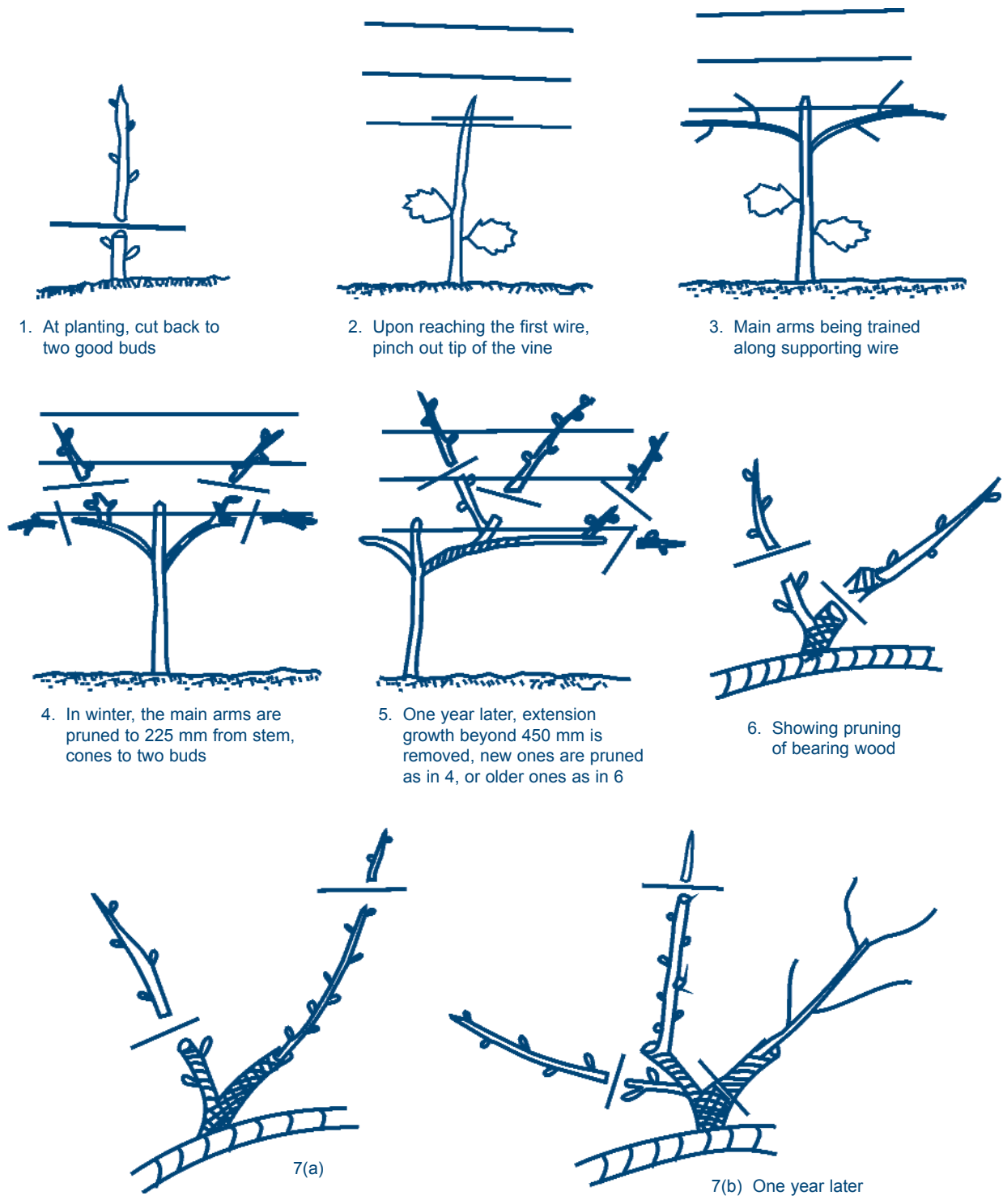

Diagrams 7(a) and (b) show modification of later pruning for vines in which only buds twelve or more from base of canes are fruitful

- **Fruit flies:** They are about the size of a house fly and two species which occur are the Natal fruit-fly (*Pterandrus rosa*) but are not as common the Mediterranean fruit-fly (*Ceratitis capitata*)
Symptoms: Eggs are laid in the ripening fruit and the larvae hatch and feed inside the berries, causing them to rot
Control: Spray or use of a bait, made of Malathion 25% WP + a fly attractant (for example maize-meal), at 30 g + 60 g/10 litres of water
 - **Fruit-piercing moth:** These migratory moths cause a great deal of damage in some seasons
Symptoms: The damage is done by the adult moths, which generally fly upwind into the vineyard at night and pierce the ripe fruit, rendering it vulnerable to other pests and diseases. During the day the moths rest in vegetation beyond the vineyard
Control: When damage is observed, spray at night with a Carbaryl, at 30 g/10 litres of water
 - **Fruit-sucking moth** Damage caused by these moths is only secondary and they are only able to feed from damaged berries
 - **Mealy bug** Mealy bugs affect leaves and shoots first and bunches later. As ants keep away the natural predators, their control is important in controlling infestations of Mealy bugs. In addition, the vines must be sprayed thoroughly when attacks occur with Carbaryl 85%, at 12 g/10 litres of water, or dust with Carbaryl 15% D, at 200g/100 m²
 - **Nematodes (eelworms)** These are microscopic in size and generally attack the roots
Symptoms: Vine appears unhealthy and on lifting the plant galls (small swellings) may be found on the roots
Control: Apply Dibromo-Chloro-Propane EC, at 50 ml/10 litres of water, or drench, at 1 litre/m². Use nematode resistant rootstocks
 - **Phylloxera:** *Symptoms:* This is an aphid-like insect, which usually attacks the roots of vines but can also attack the above ground parts
Control: No chemical is registered for the control of this pest on vines. Use resistant rootstocks and rigid phytosanitary regulations with regard to the importation of grapevines
 - **Scale:** Scale pests are sometimes found on vines. These are small sedentary insects when adult, having a protective covering. The normal winter-spray programme should help with control
 - **Thrips:** *Symptoms:* Attack the flowers and young fruits early in the season. They are troublesome on table grapes because the berry skins are disfigured by the corky lesions, which result from feeding by the insects
Control: Preventive control measures must be applied early in the growing season: spray Malathion 25% WP, at 10 g/10 litres of water
- Diseases:**
- **Anthracnose (*Elsinoe ampelina*):** *Symptoms:* This fungus causes irregularly-shaped lesions on the leaves, stems and berries. The lesions on the leaves are small at first but enlarge and have brown margins with grey centres, which drop out in time. On the stems, the lesions become elongated and young growth is distorted. On the berries, the spots are circular with purplish borders
Control: Spray Copper Oxychloride, at 50 g/10 litres of water, or Captan, at 10 g/10 litres of water. To be applied early in the growing season until main rains. Burn all infected pruned material
 - **Downy Mildew (*Plasmopara viticola*):** *Symptoms:* Appearance of pale-yellow, oily-looking spots on the upper surface of the vine leaf. Leaves in the center of the plant affected first. White fungal growth develops on the underside of the leaf, at times the whole leaf may be affected. These turn brown and defoliation may occur. Flowers and young berries may become infected and covered with a downy growth, which may lead to distortion or even death of the clusters. The disease develops during wet weather conditions and may be stimulated by overhead irrigation
Control: Spray Mancozeb 80%, at 20 g/10 litres of water, or Metiram 80 WP, at 20 g/10 litres of water, from the onset of the main rains

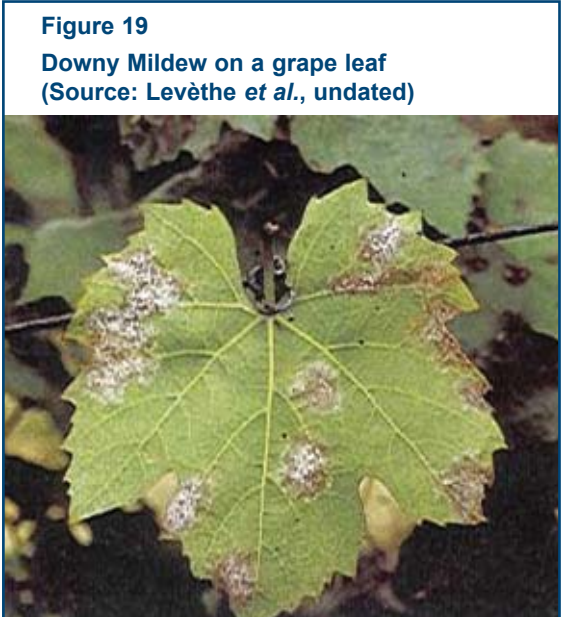

- Powdery Mildew (*Uncinula necator*): This fungus affects green parts of the vine as well as the flowers and berries
Symptoms: A white powdery appearance initially in spots that spread later. When the powdery growth is wiped off, the area underneath is seen to be brown. Growth is poor and die-back may occur. Flowers that are attacked may wither and die without setting fruit. Immature berries are susceptible and may show retarded growth and splitting. High temperatures encourage the disease
Control: Spray the same chemicals that control Anthracnose
- Die-back: Caused by *Botryosphaeria vitis* and *Botryosphaeria ribis*. These fungi are responsible for most of the die-back, which occurs in vines
Symptoms: Cankers develop on the bark, which blackens and cracks to reveal small black lumps embedded in the wood. The leaves wilt and die when the canker girdles the stem
Control: Prune and remove the source of infection by burning all prunings and dead leaves
- Dead arm (*Fusicoccum viticolum*): Not a common disease but when it occurs it causes the death of a whole arm or branch of the infected vine
Symptoms: Red-brown spots develop on the green shoots, petioles and leaves, while on the canes they are deep, continuous and may cause canes to crack. Death of the branch occurs during winter and is noticed in spring when it fails to produce leaves. During prolonged wet weather, infection can occur through wounds
Control: Irrigate by furrow or risers, in order to keep foliage and branches dry. Spray Copper Oxchloride, at 10 g/10 litres of water. Early pruning with burning of the prunings is advised
- Root rots: Fungi that cause root-rot may attack grapevines and certain rootstocks are more susceptible than others are. There is no chemical control in vines, but precautions can be taken to prevent infection. These are: avoid planting in infected soil or in shallow, poorly-drained areas, avoid over irrigating and planting weak vines
- Fruit rots: *Botrytis cinerea* and *Rhizopus* sp. may attack ripening bunches, but neither is prevalent under conditions in Zimbabwe. Much more common is a physiological condition called Water Berry that causes shrinking and browning of fruits. *Botrytis* may be controlled by application of Benomyl (see label for recommended rate) at the early bloom stage and again 3 or 4 weeks before harvest

Figure 20
Fruit rot (*Rhizopus* sp.) on grapes (Source: Levêthe et al., undated)



- Virus diseases: Several viruses attack grapevines. Infected vines should be burnt and infected soil fumigated before re-planting. All propagating material should be virus free
- Bacterial diseases: Crown Gall, caused by *Agrobacterium tumefaciens*, is the main bacterial disease known to affect grapevines. Avoid infecting vines by pruning tools and cultivating equipment. Bacterial Blight is known to occur at times. It causes cancerous lesions of buds and wood. If it occurs, infected vines should be cut back and copper sprays used to protect health vines

Physiological Disorders:

- Caused by climatic factors: Hail damage is seen as shattered leaves and defoliation, pitted berries (many of which drop), cracks and pits in stems and often broken shoots. The damage affects not only that season's crop, but also that in the following year owing to the damaged wood and reduced leaf surface that reduces food reserves and fruit bud formation. If hail strikes early in the season, damaged shoots can be pruned to spurs, allowing the growth of new shoots in that season for the following season's crop
 Moisture stress at flowering and in the following four weeks, especially when associated with high temperatures, may cause poor fruit set and berries drop
 Lighting and late frost can at times cause damage to vines

- Caused by nutritional and soil factors: Zinc deficiency can cause seedless berries and poorly formed clusters (see under 'fertilizers' how to correct)
Boron deficiency may prevent normal pollen development, with resultant poor fruit set (see under 'fertilizers' how to correct). Inadequate watering may cause high salinity in the soil, which means high total concentration of salts. Symptoms may include poor yields, stunted vines and leaves browning from the edges. To correct this problem, it is necessary to leach the salts from the soil by heavy watering, provided the soil is well-drained and the water is of very low salt content

8.6. Mango

Scientific name: *Mangifera indica*

Family: *Anacardiaceae*

- Cultivars:
- Tommy Aktins: High-quality fruit and excellent scarlet red colour. Suitable for growing in most mango growing areas. Fruits weigh up to 450 g. Harvesting period mid-December to end January
 - Zill: Colour is scarlet to dark red when mature, excellent internal quality and a long shelf life. The fruit tends to ripen prematurely around the seed. The flesh becomes watery, soft and yellowish around the seed before fruit ripens fully on the outside. Pick at the mature green stage to reduce the problem. The cultivar is resistant to bacterial black spot infection. The fruit weight is about 350g. Harvesting period early December to early January
 - Fascell: Produces fruit that is scarlet to dark red. It is a medium-sized fruit, good internal quality. Good and regular fruit bearer. Cultivar is resistant to black spot. Harvesting period mid-December to end of January
 - Van Dyke: Good cropping cultivar with excellent external colour and flesh quality. Medium-sized fruit and is produced in mid-season
 - Sensation: Produces beautiful coloured 250 g oval fruit of excellent quality, but which does tend to ripen unevenly on trees prone to biennial bearing. Sensation is very resistant to bacterial black spot. Cropping season is from the end of January to mid-March
 - Kent: A late cultivar with greenish-yellow fruit colour with a dark overall blush, excellent flesh quality, and a heavy regular bearing. Can be recommended only for warm areas where the season is long enough for the fruit to mature. It is very susceptible to bacterial black spot, and is harvested early March to end of April
 - Keitt: Produces a large plump fruit, which ripens late. If grown under suitable climatic conditions, which include a warm late summer, it produces fruit of excellent external and internal quality. The fruit weighs 900 g and the cropping season is from early March to end of April. However, based on its performance in Chiredzi Research Station, "Keitt" is not recommended in Zimbabwe

Soil: Light, friable soils. Depth of 75 cm. Good drainage. Mangos are sensitive to acid soils

Climate: Select one of the above cultivars that suits the climate. Grow early, mid-season and late cultivars in the low altitude areas with warm temperatures and low rainfall. Production period from early December to mid-April. Avoid late cultivars in the high altitude areas where temperatures get cool from March to July

Production areas: Frost-free with high temperatures from early August to April

Fruit colour and quality: For the best on the market, be it local or for export, the mango should be free of fibre, of attractive colour and good flavor and should without the turpentine taste

Production period: Spreading the production period by using a range of cultivars from mid-November to April is an advantage. This should influence the selection of the cultivar.

- Orchard establishment:
- Site selection: Select a warm lying, frost-free area where irrigation is possible. Plant the orchard on a warm northern-facing side to avoid frost. In high altitude areas, young plants can be protected from frost by sheltering them with grass. Avoid mulching the trees, since mulch attracts frost. Soils should be loose and friable sandy loams with a minimum depth of 75 cm. Avoid heavy soils
 - Land preparation: The land must be well prepared, ripped to a depth of 60 cm and levelled. If the slope is more than 2%, soil conservation measures are necessary. Windbreaks are not recommended, there must be free flow of air
 - Tree spacing: Since mango trees bear fruit on the outside, they require a free space of 1.2 m all round, otherwise fruiting is greatly inhibited. It is preferable, therefore, to space mango trees too widely rather than too closely. The recommended space when the trees are 12 years old should be 10.5 m x 10.5 m. The cultivar 'Tommy Atkins' can be spaced at 7 m x 7 m to

	<p>8 m x 8 m eventually. Such a wide space, however, wastes land during the first 12 years. Since mango trees bear early, the grower should consider double or quadruple density planting even if he has plenty of land available. The main initial cost to the farmer will be the cost of the trees. Once the farmer has enough trees to supply bud wood, he/she can propagate her/his own trees. After about 12 years, the removal of the filler trees will be necessary. If the farmer decides to only double density plant along the rows, he/she can interplant with three rows of papaya, which have a life of 4 years</p>
• Orchard layout:	If the land is fairly level, the grower can plant on the square system. This is done by marking out the base line and at the same time putting a peg for each plant position. The rows are then set out at right angles to the baseline
• Planting the trees:	Each hole is dug in the exact position where the marking peg was. The size of the hole should be about 75 cm x 75 cm on top and of sufficient depth to allow the tree to be planted at soil level. The soil to be put back into the hole should be mixed with ½ kg Single Super Phosphate. The plant (still in the plastic container) is placed in the hole and raised, if necessary, by putting soil underneath to about 5 cm above the surrounding ground level to allow for settling. The plastic container is carefully removed and the hole is filled with soil. The best planting period is in October, which allows the trees to be well established during the coming rainy season
• Care of young trees:	To encourage rapid growth, for the first 3 years young mango trees are given more nitrogen in proportion to their size than bearing trees. The nitrogen should be split into 4 applications during the growing season and applied in a circle 0.5 m away from the vase of the stem the first year and afterwards in a circle around the drip area. Regular irrigation should be given year round and the ground should be kept clean from weed growth well outside the drip area. When the trees are 3 years old they are treated as mature trees
• Care of mature trees:	Although most of the mango tree roots are in the first 60 cm of soil, several strong roots will penetrate more than 4 m deep, which accounts for the drought resistance of the trees. Clean cultivation over the root spread should be shallow and regular. Paraquat herbicide can be used to keep the root area of young trees free from weeds. Mature trees give a dense shade underneath and to a large extent this suppresses weed growth. Soil absorbs heat during the day and releases it to the atmosphere during the night. Mulching the root area of mangoes restricts the release of heat from the soil and may result in frost and damage to the trees
Fertilizers:	<p>Mangoes grow best in soils with pH values of 6.0-7.2. At lower or higher pH values, plants may suffer from trace element deficiencies</p> <p><i>Phosphate:</i> The available phosphate content of the soil should be at least 20 ppm P₂O₅ (resin extraction method). No reaction to phosphate application can be expected if the soil contains more than 50 ppm phosphorus</p> <p><i>Potash:</i> The recommended potassium status of the soil for mango cultivation lies somewhere between 80 and 200 ppm</p> <p><i>Application:</i> 220 g of AN and 220 g of SSP per tree per year of age, up to a maximum of 5 kg AN per tree per year for old trees (> 20 years). Under lowveld conditions no Potassium is applied, however leaf analysis must be done. Where it is necessary to apply potassium, only the sulphate form should be used, as mangoes are sensitive to the chloride ion</p> <p><i>Application time:</i> During the first 3 years the fertilizers are applied in at least 4 split applications throughout the growing season. From the 4th year onwards, the phosphate is applied in the winter, the potash in September and the nitrogen in split applications: (i) just before flowering, (ii) immediately after harvest and (iii) after harvesting</p>
Pruning:	<p><i>Young trees:</i> The framework of the young tree is formed so that 3-5 leaders grow from the trunk. Strong cropping branches are suitably spaced, growing outwards from these leaders. Branches that are too near the ground are removed. Formative pruning should be done before the shoots get too long, otherwise large branches must be removed and the trees suffer a setback</p> <p><i>Tree size control:</i> Topping the main leaders may control the tree height. The shoots, which develop near the apex of the topped leaders, must be thinned out. Where trees are touching, cropping will decline. It is better in this case to thin out trees rather than trim back</p>
Harvesting:	The fruit is picked when the outer ground colour development has reached the correct change for the particular cultivar. When harvesting, the fruit should be clipped from the trees leaving about 1 cm of stalk on the fruit. The picked fruit is gently placed in crates. The crates of fruit should be kept under shade. It may be necessary to carry out up to 10 pickings per tree per season
Expected yields:	15-25 tons/ha per year can be expected annually from the 6th year from intensive mango orchards
Storage:	Mangoes should be stored at 13°C and 85-90% relative humidity. Although the fruit will keep 2-3 weeks in storage, the shortest possible storage time should be used to allow for the inevitable storage period during transit and longer shelf life in the market

- Pests:**
- **Fruit flies** Mangoes are attacked by both the Mediterranean and the Natal fruit flies. The control of diseases such as bacterial Black Spot, which rapture the skin of the fruit, are of great importance as the fruit flies are attracted to the infected fruit
Control: Exercise orchard hygiene by removing and burying all decaying fruit. Bait with Malathion 25% WP + sugar, at 30 g + 800 g/10 litres of water, from the time the fruit matures until harvesting gives satisfactory control

 - **Mango weevil:** This is now distributed throughout the world where mangoes are grown
Symptoms: The adult female lays her eggs singly on the surface of young fruits and covers each with a cement-like secretion. The hatched larvae penetrate to the seed of the fruit when they feed. The development from larva to adult is comparatively long. In the case of early mango cultivars it is longer than the ripening period of the fruit and in consequence of minor importance. Where the development of the larva is shorter than the ripening period of late cultivars, the adult weevil leaves the fruit by tunneling through the flesh thereby causing damage and secondary infection
Control: Since there is no alternative host, the main source of infection are seeds lying around, where the weevil can enter and stay during winter. Regular removal of decaying fruit and seed should be carried out during the season. The fruit and seed should be buried at least 60 cm deep

 - **White mango scale:** *Symptoms:* These immobile insects appear as raised white spots on the under and upper surfaces of leaves, and also sometimes on branches and fruit
Control: Use Folidol (Parathion) 25% WP, at 200 g/litre of water, in winter immediately before flowering. It is effective, though it is highly toxic. Malathion can be used, but is only effective on young mobile scales in the 'crawler' stage. A light oil spray can also be used in winter
- Diseases:**
- **Anthraco-nose:** Caused by fungus *Colletotricum geasesporioides*
Symptoms: It generally infects the fruit during the critical period from flowering until the fruit are ¾ size. The most serious aspect of this disease is that the fungus invades the skin of the young fruit and remains in a latent state until fruit ripening begins, giving rise to black spots which may coalesce, resulting in extensive rotting. This disease is often referred to as ripe-rot and is present in most mango-producing countries throughout the world
Control: Use Copper Oxychloride and Copper/Zineb mixture at the same rate as recommended for bacterial Black Spot. Or use Mancozeb 80% WP or Maneb 80% WP, at 220g/100 litres of water. First spray should be 3 weeks after petal fall (when the fruit is about pea or marble size) and a second spray when the fruit is full size. Hot water treatments have been suggested as a post-harvest control of Anthracnose on mangoes. The hot water treatment consists of submerging a batch of fruit in water of 52°C for 5 minutes. Improved effectiveness in killing latent infections of both Anthracnose and Diplodia stem end rot has been reported if a fungicide is included in the water during heat treatment. Dipping fruits in Benomyl, 500 ppm, or Thiobendazole, 900 ppm, has been reported effective against latent infections of anthracnose on mangoes

 - **Bacterial Black Spot:** This is a severe mango disease. The appearance of Anthracnose is usually delayed until maturity, but bacterial Black Spot may be seen on young green fruits and for this reason is referred to as 'green rot'. It becomes most active at the onset of the rains, with the spreading of infection from the old lesion to the healthy fruit. If moist conditions continue, the disease spreads rapidly, causing severe losses
Symptoms: The main diagnostic symptom of bacterial Black Spot is that the surface lesions have raised cracks, unlike the smooth surface of Anthracnose lesion. Recommendations on suitable fruit cultivars must be finally decided on the susceptibility of the cultivars to the two serious diseases referred to above. The problem becomes complicated because some of the cultivars that are resistant to Anthracnose are susceptible to bacterial Black Spot and

Figure 21
Anthraco-nose on a mango leaf and fruit (Source: University of Florida, 2000)

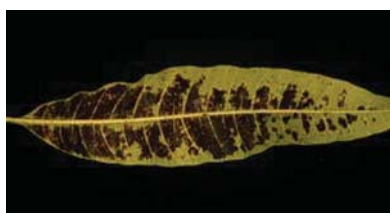

a. Anthracnose on leaf

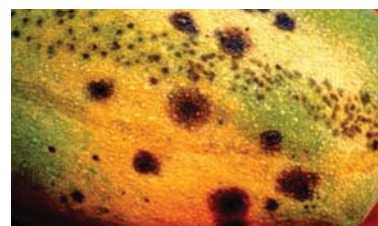

b. Anthracnose on fruit

- vice-versa. Black Spot is transmitted through the grafting wood and is not transmitted by seed. To establish bacterial Black-Spot-free orchards, seedlings raised locally can be grafted onto suitable cultivars with disease-free graftwood
- Control:* Spray Copper Oxychloride 85% WP, at 300 g/100 litres of water, or a commercial mixture of 64% Copper Oxychloride WP and 20% Zineb WP, at 400 g/100 litres of water. The first spray should be applied at fruit setting and thereafter every 14 days in moist conditions and every 28 days in dry conditions. A safety period of 14 days must be observed before harvest. The spray may cause russetting on fibreless cultivars
- Powdery Mildew (*Oidium mangiferae*): This affects the flowers, leaves and young fruit. Under a severe attack, the flowers die and the fruit fails to set
Symptoms: White powdery growth on the flower clusters and undersurface of the young leaves. Powdery Mildew is particularly destructive when the weather is cool and dry at flowering
Control: Use Bupirimate 23% EC, at 40 ml/100 litres of water, Chinomethionate 25% WP, at 25 g/100 litres of water, or Pyrazophos 30% EC, at 40 ml/100 litres of water. Spraying flowers with Sulphur and Sulphur/Copper Oxychloride powder also controls the disease. To effectively control this disease without adversely affecting crop size, it is important to spray as soon after bud break as possible. Dusting the tree flowers with Sulphur or with the Sulphur/Copper Oxychloride mixture is as effective as the fungicidal sprays. Failing early effective control, it may be necessary to repeat the treatments several times at 14 day intervals until fruit set
 - Flower malformation: *Symptoms:* The disease is characterized by the development of a swollen apical bud, which gives rise to a number of flowers with shortened inter-nodes and scale-like leaf structures forming a compact mass resembling a cauliflower
Control: Remove all infected shoots by pruning them back to healthy wood. The wound must be sealed and the prunings burned. Badly infected trees must be removed completely and burned

8.7. Passion fruit (Maracuja, Grenadilla)

Scientific name: *Passiflora edulis*

Family: *Passifloraceae*

Cultivars: Purple Granadilla and Yellow Granadilla

Soil: Passion fruit can grow on a wide range of soils, as long as they are well-drained and disease-free

Climate: Passion fruit can be planted year round in frost-free areas. The optimum temperatures for production are between 20 and 30°C. Growth is poor when temperatures drop to 6°C. Above 32°C vegetative growth is promoted at the expense of flowering and fruit yield. Older vines are frost tolerant to some extent, but young vines are very susceptible to frost damage. Temperatures below 20°C reduce pollination. Selecting cooler south facing slopes in hot areas and warmer north facing slopes in cooler areas will benefit the crop. Wind causes fruit to be bruised, reducing appearance and quality. Where winds are strong, windbreaks are recommended

Planting time: In cooler areas, plant from September to December

Plant material: Obtain seedlings from a reputable nursery

Transplanting: Transplant when seedlings are 15 cm tall. They must have been hardened off well. Plant during cool weather and plant to the same depth

Planting method: High density: Intensive system. Low density: Extensive system

Plant population: Intensive system: 16 000-25 000 plants/ha. Extensive system: 5 000-7 000 plants/ha

Crop duration: 12 months from seed or 5-7 months from transplanting

Trellising: A trellis must be constructed strongly to avoid collapse. Rows should be oriented in a north-south direction to maximize exposure to the sun

- *Intensive system:* In this system an overhead trellis is used, on which plants form a canopy (Figures 22 and 23). Rows are spaced 4 m apart and the within row spacing is 10 cm to give a plant population of 25 000 plants/ha. Each vine is trained to the top wire and horizontally in the direction of the prevailing wind, until it reaches the opposite row. Vines must be wound loosely around wires to prevent damaging the plants. Remove all suckers
- *Extensive system:* The crop is grown on a simple vertical system (Figures 24 and 25). Rows are planted 1 m and 2.5 m apart alternately, to facilitate tractor movements. Plants are planted in pairs, 20 cm apart with 2 m separating each pair. Plant population of 5 714 plants/ha. One plant is trained to the top horizontal wire and along it. The second plant is trained to the low horizontal wire. Laterals are allowed to grow and hand down. Remove all suckers from these laterals on a regular basis

Figure 22

Passion fruit high-density (intensive system) trellis plan: Plan view (Fresh Produce Producers' Association, 1999)

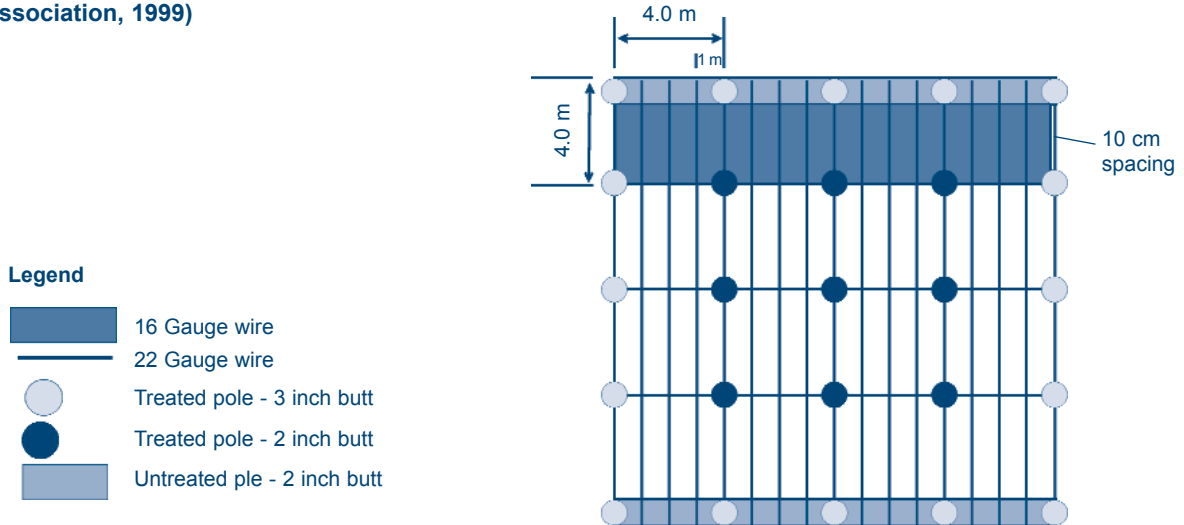

Figure 23

Passion fruit high-density (intensive system) trellis plan: Side view (Fresh Produce Producers' Association, 1999)

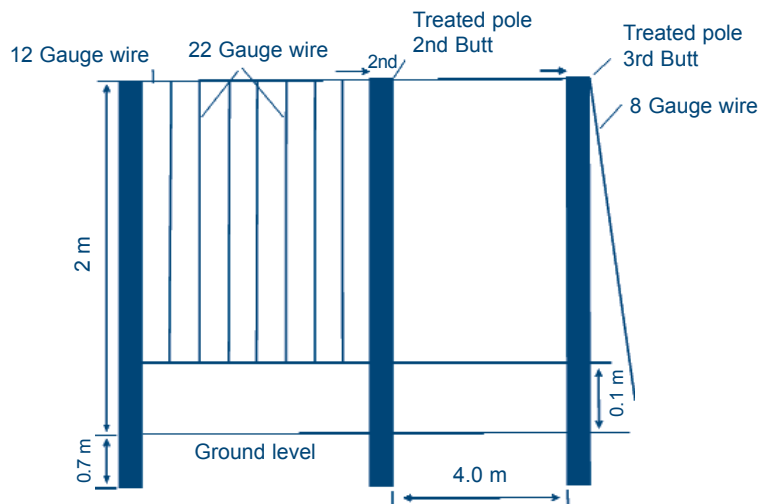

Figure 24

Passion fruit low-density (extensive system) trellis plan: Side view (Fresh Produce Producers' Association, 1999)

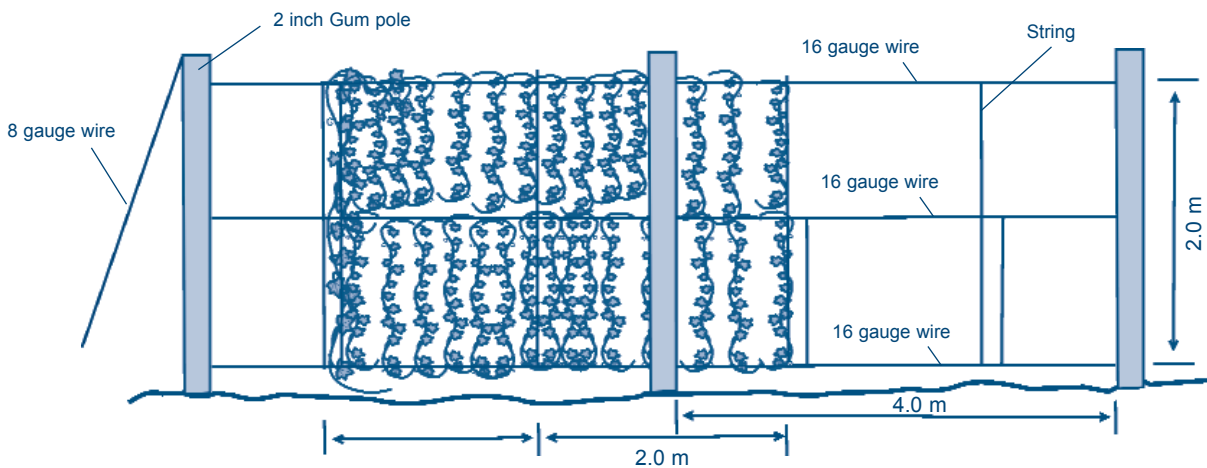
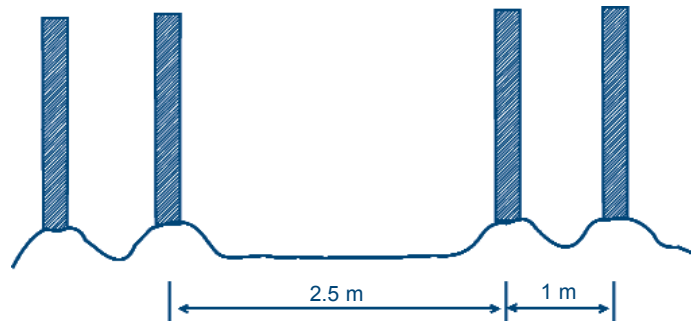

Figure 25

Passion fruit low-density (extensive system) trellis plan: Cross-section (Source: Fresh Produce Producers' Association, 1999)

Plant population - 5 714 plants/ha
 16 Gauge wire - 1 742 m (275 kg)
 8 Gauge wire - 6 000 m (60 kg)
 2,7 m x 2" Treated gum poles - 1 429



Cultural practices:	<ul style="list-style-type: none"> • Training: Correct trellising is essential to give sufficient light to colour the fruits, to reduce insect pests and disease pressure and facilitate management. Irrespective of the system used, the following should be observed: The main stem should be wound loosely around wires Laterals must be untangled to allow them to hang freely During pruning, the scateurs must be sharp and wounds painted with an inert paint. Tools should be disinfected when moved from one plant to the other • Cutting back: Flowers and fruits develop in current season growth, hence pruning is advised to rejuvenate growth, increase air circulation and light penetration. Pruning should be carried out in dry weather to reduce diseases, once a year after fruit harvest <i>Intensive system:</i> Severe pruning from year one is advised. Remove all the suckers. After harvest cut back to 30 cm above the ground, 12-16 months after transplanting <i>Extensive system:</i> Vines are cut back after harvesting all the fruits from the hanging laterals, 12-14 months after transplanting. Spray to prevent possible Phytophthora infection. Cut back main leaders to about 30 cm below their respective wires. Protect against Anthracnose by painting the cut wounds with a strong fungicide • Weeding: Hand weeding is advised avoiding damage to the shallow root system. Mechanical weed control is not encouraged
Fertilizers:	<p>Manure: 10-20 tons/ha before planting Phosphate: 200 kg/ha Single Super Phosphate, apply and incorporate before establishment</p> <p><i>Intensive system:</i> <i>Before planting:</i> 150 kg/ha of a compound mixture of N:P:K ratio of 10:20:10 <i>Before flowering:</i> monthly 50 kg/ha of Ammonium Nitrate and 150 kg/ha of Compound J. <i>After flowering:</i> monthly 100-150 kg/ha of Ammonium Nitrate, 100 kg/ha of Muriate of Potash (MOP) and 75 kg/ha of Lime <i>After cutting back:</i> 200 kg/ha Compound J</p> <p><i>Extensive system:</i> <i>Before planting:</i> 100 kg/ha of a compound mixture of N:P:K ratio of 10:20:10 <i>Before flowering:</i> monthly 30 kg/ha of Ammonium Nitrate and 75 kg/ha of Compound J <i>After flowering:</i> monthly 75-100 kg/ha of Ammonium Nitrate, 75 kg/ha of Muriate of Potash (MOP) and 75 kg/ha of Lime <i>After cutting back:</i> 150 kg/ha of Compound J</p>
Harvesting:	Pick fruits when they are 90-95% coloured, depending on the distance to market. Keep fruit in the shed after picking. Intensive system yields are 15-30 tons/ha. Extensive system yields are 8-15 tons/ha
Pests:	<p>Regular scouting is advised. Avoid spraying when bees and other pollination insects are active</p> <ul style="list-style-type: none"> • Fruit fly and Pumpkin fly: <i>Symptoms:</i> These insects lay eggs in the fruit while the fruit is young and developing. A round depression is formed, with a small hole in the middle. A soft brown area develops around the spot <i>Control:</i> Use weekly bait sprays of Malathion 25% WP + sugar, at 30g + 800 g/10 litres of water • Nematodes: Common in sandy soils. Affects root development. Preventative control with nematicides before planting is advised. Biennial drenches in August and February • Thrips: <i>Symptoms:</i> Their feeding and egg-laying may cause small white blemishes on the fruit. Common during warm dry September conditions. They cause distorted leaf growth and enhance flower drop <i>Control:</i> Apply Thiodan 50 WP, at 10 g/10 litres of water

- Tip wilters: These are large black stinkbugs with spiny projections on thorax and legs. Their sap-sucking activity causes the wilting and dying of shoot tips. Hand collection is the most effective control
 - Green Stink Bugs: Cause damage by piercing young fruit, that later becomes discoloured and not of good quality. Hand picking is the best method
- Diseases:
- Damping Off: Caused by a number of pathogens like *Pythium* and *Rhizoctonia*
Symptoms: Wilting seedlings, with water-soaked girdling of the stem at or just below soil surface
Control: Good nursery practices and dressing the seeds with fungicides
 - Leaf and Fruit spot: Caused by a number of fungal pathogens, such as *Septoria*, *Alternaria* and *Cladosporium*.
Symptoms: Necrotic, round to angular lesions on both the fruit and the leaves and on shoots. The disease spreads when conditions are wet and humid. Affected leaves later die and drop off, while the fruits are downgraded
Control: Good pruning and orchard management is essential to minimize disease
 - Powdery Mildew: Causes leaves to become yellow and drop off
Symptoms: White powdery patches on the undersides of the affected leaves
Control: Spray Bavistan, at 5 g/10 litres of water, or wettable Sulphur (read the label for the recommended rate of application)
 - Phytophthora: Causes yellowing of the vines, starting at the tips
Symptoms: Dark water-soaked areas on the stem, which develop to swollen areas. The swelling becomes corky and dry and the bark gets rough and cracks, resulting in wilting and death of the plant. It is a common disease in older plantations
Control: Good drainage and use of chemicals like Bravo and Dithane M45, at the rate recommended on the label
 - Bullets disease or mosaic woodness: Caused by a virus
Symptoms: Fruit becomes lumpy, with a thick skin and little pulp
Control: Plant virus-free seedlings and remove and destroy infected vines
 - Anthracnose: Occurs where vines have been damaged or cut
Symptoms: The tissue near the wound dies, spreading down the plant and causing its death
Control: Paint cut and damaged areas with a strong fungicidal solution of Dithane M45, at 30 g in a little water to make a paste

8.8. Peach, plum, apricot and nectarine (stone fruits)

Scientific name: *Prunus persica*, *Prunus domestica*, *Prunus armenica* and *Prunus persica*

Family: *Rosaceae*

Cultivars: There are two main types of peach cultivars. Freestone used for fresh eating, with soft flesh that separates easily from the stone. Clingstone used for canning as well as fresh eating, with firm flesh joining the stone. There are some semi-freestone peach cultivars as well. Most of the low-chilling peach and apricot cultivars are self-fertile and do not need pollinator cultivars. A list of some examples of names and characteristics of low chilling requirement cultivars is given in Table 24 below. It is important to note that new cultivars for stone fruit are always being released, especially from South Africa.

Soil: The soil should be deep and well-drained with pH 5.0-5.5 (CaCl₂) and a high organic matter content, which can be obtained by the addition of well rotted compost or kraal manure. This, however, will also encourage termites

Climate: Stone fruits originated from cool temperate regions, where they drop their leaves in winter and begin to grow again when it gets warm in spring. These fruits require a cold winter to grow new leaves, produce flowers and set fruit. If the winter is not cold enough, the trees will not flower and produce leaves or they flower and produce new leaves over a long period of time. This will result in poor fruit yields and occasionally the tree dies. In Zimbabwe, stone fruits can only be grown in the cooler upland areas that get frost in winter. Like pome fruits, stone fruits have chilling requirements. Peaches need the least cold, followed by nectarines, plums and apricots. Different stone fruit cultivars have different chilling requirements. Low-chilling requiring cultivars should be grown in countries like Zimbabwe. They should be planted in the coolest part of the land. South-facing slopes are cooler than slopes facing other directions. Bottom of slopes and along rivers and streams, where cold air collects at night, are ideal places for a stone fruit orchard

- Orchard establishment:
- Site selection: Sites that receive the highest chilling, for example the bottom of a slope, are most suitable. However these sites should not be susceptible to late frost, since the flowers of deciduous fruit trees are very sensitive to frost
 - Land preparation: Trees, natural bush or old fruit trees, should be ring barked at least two seasons prior to envisaged planting in order to control Armillaria root rot. These trees should then be removed including as much root material as possible. If possible, there should be two seasons with no trees growing in the field

Table 24

List of stone fruit cultivars (Source: Forestry Commission, 1995)

Stone Fruit	Flesh Colour	Stone	Use
Peach			
Babcock	White	Semi-free	Fresh, export
Boland	White	Semi-free	Fresh
Earlibelle	White	Semi-free	Fresh
Safari	Yellow	Free	Fresh
Sunray	Yellow	Semi-free	Fresh
Kakamas	Deep yellow	Cling	Canning
Apricot			
Alpha	Light yellow		Fresh, drying
Early Cape	Light orange		Fresh, drying
Late Cape	Light orange		Drying
Piet Cillie	Orange		Fresh, drying
Plum		Pollinator	
Eclipse	Red on Yellow	Santa Rosa	
Methley	Red	No pollinator	
Satsuma	Red	Santa Rosa	
Harry Pickstone	Yellow	No pollinator needed	
Songold	Yellow	No pollinator needed	
Ruebennel	Red	No pollinator needed	

- Tree spacing: Peach and Nectarine: 7 m x 7 m. Apricots and Plum: 5.5 m x 5.5 m. Plum trees need pollinators. Plant in alternation, if the commercial cultivar and pollinator are of equal commercial value. If the pollinator is of no commercial value, plant one pollinator for every nine trees.
- Planting the trees: The dormant season (late June to mid-August) is best time for planting. The trees are planted bare root with no soil covering the roots. Drying of the roots should be avoided by covering plants or roots with a moist sacking between uprooting from the nursery and planting. Trees should be planted to the same depth as they were in the nursery. Cut back trees to a height of about 60-75 cm from the ground
- Care of young trees: Stone fruit trees should be allowed to produce fruit in the 4th year, after the tree structure is well made.

Pruning:

Stone fruit trees must be pruned every year. Pruning, which is the cutting of branches of trees, is an art that requires patience and experience. It is done for the following reasons:

To increase the size of fruit – pruned trees produce fewer but larger fruits

To reduce and control the height of the tree, so that all the fruits can be reached when picking

To remove diseased and dead wood

- At planting: Cut back trees to about 60-75 cm from the ground. During the first growing season, remove all suckers arising from below the graft union. This is best done when the shoots are still small (when they can be rubbed off with the fingers). Removal of larger shoots may result in wounds that serve as entry points for disease-causing organisms
- 1st winter after planting: Select 3-4 scaffold (main) branches, evenly spaced around the main trunk. These are the the main branches and will be maintained throughout the productive life of the tree. If trees are to be trained to the centre leader from the top, most shoots should be trained vertically. The other common training system is the vase-shaped or open centre training, meaning that there is no middle shoot. Any diseased, damaged or dead wood should be removed and care should be taken to keep pruning to the necessary minimum, unless trees are weak and small. Hard pruning during the early years will delay cropping of the trees
- 2nd winter after planting: On cropping trees, the objective of pruning is to maintain a balance between vegetative growth and fruiting. In peaches, fruit are borne on one-year old wood. It is important to encourage new growth by cutting back alternate side branches to about a 1/3 of their original length and to a weaker shoot. Dead, diseased and damaged wood should also be cut out. All water shoots are cut out cleanly at their point of origin (thinning out). There are two types of pruning cuts:
 - Thinning cut*: this involves complete removal of an entire branch by cutting cleanly (flush with the trunk) from its point of origin. The result is a more open spreading canopy. This system is more suited to pruning vigorous dense trees
 - Heading cut*: this involves cutting back a shoot immediately above a bud. This will stimulate growth of the remaining buds into a compact canopy

- Fertilizers:**
- Initial:**
Either 750-1000 g of Compound J per planting hole, mixed with the topsoil plus 1000 g lime if necessary, or 600 g SSP + 300 g Potassium Sulphate (K_2SO_4) + 200 g AN. After planting, top dress with 50 g AN per tree every six weeks until March
- 2nd cropping year:**
In August: 150 g AN and 75 g Potash per tree. In November: 75 g AN and 40 g Potash per tree
- 3rd cropping year:**
In August: 250 g AN and 125 g Potash per tree. In November: 125 g AN and 70 g Potash per tree
- Depending on the growth and productivity of the tree, the amounts may be increased in subsequent years to a maximum of 500 g per tree for AN and 300 g per tree for Potash. Alternatively, in August 500 g of Compound J can be given per tree and in November 250 g of Compound J. These amounts may be increased to a maximum of 1000 g per tree for August and 500 g for November
- These are only approximate recommendations. It is best to obtain soil analysis results and recommendations
- Fruit thinning:** This is required in order to improve fruit size and remove misshapen fruits. The best time of thinning is 2-4 weeks after full bloom and should be completed 30-40 days after full bloom and before the stone (seed) hardens. The fruit should be thinned to one fruit per 15 cm space, which is roughly one hand span
- Harvesting:** The time of picking the stone fruit depends on how far away the markets are. If the fruits need to be transported over quite a distance, harvest when they first change colour. If the fruits are for selling locally, then pick when the colour is fully developed. Stone fruits are soft and easily damaged if they are being transported. To avoid this, pack them in straw or soft paper in wooden or cardboard trays that can only accommodate one layer.
- Pests:**
- **Codling moths:** *Symptoms:* The larvae tunnels into the fruit are filled with crumbly brown excrement. The larva is pale pink, with a brown head. The adult moth has grey front wings with brown markings across them and bright bronze markings on the edges
Control: Spray Lebaycid WP, at 10 g/10 litres of water, when 75% of flower petals have dropped
 - **Fruit flies:** The flies are smaller than houseflies and have black bands on the wings
Symptoms: They lay eggs in immature fruits and the larvae hatch and feed in the fruit causing a lot of damage
Control: Bait with Malathion 25% WP + sugar, at 30 g + 800 g/10 litres of water, or use Lebaycid, at the rate on the label. It is important to start the control from flowering onwards
 - **Scale insects:** Pernicious scale is the most serious
Symptoms: Dead shoots and branches, as well as fruit drop. Trees grow badly
Control: Prune out and burn infected branches. Spray Parathion 25% WP, at 20 g/10 litres of water, after leaf drop and again 4 weeks later in winter when trees are dormant
- Diseases:**
- **Rust:** *Symptoms:* Small yellow spots appear on the upper surface of leaves with brown pustules on the underside. These spots may spread and early defoliation may occur
Control: Use Dithane M45, at 20 g/10 litres of water, just before the buds open 10 days after flower petals drop. Apply again after 3 weeks and 3 weeks after that and then after harvest
 - **Leaf curl:** *Symptoms:* Part of the leaf becomes puckered and curled and has a yellowish to red colour. It usually occurs in spring. Once the leaf curl fungus is on the new spring leaf growth, it cannot be controlled. Spraying must therefore be preventative
Control: Use Lime Sulphur, at 1 litre/10 litres of water. Apply before the end of May when most leaves have dropped. Spray Lime Sulphur again 2 weeks before the buds begin to grow in spring, at 500 ml/10 litres of water, or Copper Oxychloride, at 50 g/10 litres of water
 - **Gum spot:** *Symptoms:* A fungal disease, which appears as sunken, round purple spots on leaves that change to brown and fall out. Purple brown cankers or bumps on young shoots that crack and ooze gum. This can cause the shoot to die
Control: Prune all infected shoots. Collect and burn the prunings. Spray Lime Sulphur, at 1 litre/10 litres of water, plus Copper Oxychloride, at 40 g/10 litres of water. Apply Copper Oxychloride before the end of May when most leaves have dropped and again 2-3 weeks before the buds begin to grow in spring, at 50 g/10 litres of water
 - **Powdery Mildew:** A fungal disease that infects leaves, young shoots and fruit
Symptoms: The young leaves are covered in a white powder, and may curl up and become narrow. The older leaves have white powdery blotches on the underside. The leaves may dry and drop. On the fruit, there are white patches that become hard and crack. The disease is common in wet weather in autumn and spring
Control: Remove all infected shoots during pruning and burn them. Apply Lime Sulphur, at 500 ml/10 litres of water, just before the buds open. Spray again Lime Sulphur, at 250 ml/10 litres of water, when buds are pink. From mid-October, spray Lime Sulphur every 2 weeks until December, at 65 ml/10 litres of water

Chapter 9

Agronomic aspects of field crops

The sections below give the agronomic aspects of the most important field crops in the sub-region. The information refers to the climatic conditions prevailing in Zimbabwe (Chapter 1) and should be adapted for other countries, if the conditions are different. For information on crop water and irrigation requirements, the reader is referred to Module 4. The names and quantities of chemical fertilizers for fertilization are also given below, as are the chemical

products for treatment of pests and diseases. As explained in Chapter 3, wherever possible organic fertilizer should be added. It should be noted that different control methods of pests and diseases are possible as explained in Chapter 4. Integrated Production and Pest Management (IPPM) is becoming more and more successful in the sub-region (Chapter 5) and its application, wherever possible, is highly recommended.

9.1. Dry bean

Scientific name: *Phaseolus vulgaris*

Family: *Leguminosae*

Cultivars: Several varieties available but the most common is the Sugar bean

Soil: Well-drained soils, with good organic matter content. pH 5.0-5.5

Climate: Sensitive to frost. Summer crop between August and March

Seed amount: 130 kg/ha

Planting depth: 2.5 cm

Spacing: 40-60 between the rows and 7 cm within the row

Planting time: Beans can not stand any frost while high temperatures will affect flowering and pod setting. Lowveld: plant at the end of the summer. Highveld: Do not plant during winter, if there is frost in the area

Growth period: 4-4.5 months, including harvest

Fertilizers: *Basal application:* 600 kg/ha of Compound D

Top dressing: Beans can fix nitrogen naturally and too much nitrogen fertilizer will promote vegetative growth only. Depending on the state of the crop, there may be need for a shot of 100 kg/ha AN to start off the growth. One application of 100 kg/ha AN after flowering could also be necessary

Harvesting: Harvest when pods are almost dry but not too dry to shatter in the field. Beans need to be harvested and placed in an open shed during the rains or in the open air to further dry before thrashing

Expected yield: 3-5 tons/ha

- Pests:
- Bean Stem Maggot (BSM) (Beanfly): Generally regarded as the principal insect pest of beans throughout Africa. It attacks also other crops, including cowpea and soybean
Symptoms: The leaves of damaged plants show mining tracks where the maggots feed. The lower parts of the stems become dry, swollen and cracked. Attack by this pest often causes death of young bean plants. Damage by the BSM is more serious in dry areas where yield losses can be as high as 50 to 100%
Control: Improved management practices. Improving fertility leads to vigorously growing plants that are able to tolerate BSM infestation and damage better. Seed dressing with various insecticides, such as Thiodan 50WP, at 5 grams/kg of seed at least during the seedling (and most susceptible) stage. Foliar application of some botanical insecticides including neem seed extracts during the early seedling stages. Mulching with cut weeds or straw and earthing up soil in ridges or mounds around the base of the plant, which promotes root establishment
 - Aphids: *Symptoms:* Stunted growth with inside curled leaves with aphids at growing tips
Control: Use Metasystox 25 EC, at 10 ml/10 litres of water
 - Caterpillars: *Symptoms:* Eat holes in the leaves at night and are dangerous in initial stage
Control: Use Carbaryl 85% WP, at 20 g/10 litres of water
 - Red Spider Mite: *Symptoms:* Small, red insects on underside of leaves, making small webs, sucking sap and making the leaves dry and curl
Control: Apply Metasystox 25 EC, at 10 ml/10 litres of water on the lower side of leaves

- Diseases:
- Bacterial Blight: *Symptoms:* Yellow haloes on leaves and pods
Control: Use resistant varieties. Apply Copper Oxychloride 85% WP, at 40 g/10 litres of water, to suppress
 - Bacterial pustule of leaves (*Xanthomonas* sp.): *Symptoms:* Water-soaked spots on pods
Control: Use resistant varieties and apply Copper oxychloride 85% WP, at 40 g/10 litres of water, to suppress
 - Anthracnose: *Symptoms:* Sunken, dry spots on leaves and pods
Control: Use of Dithane M45, at 30 g/10 litres of water every 10 days
 - Scab: *Symptoms:* Malformations on pods
Control: Use Dithane M45, at 30 g/10 litres of water, every 10 days
 - Angular leaf spot: *Symptoms:* Spots on pods, but not water-soaked
Control: Apply Dithane M45, at 30 g/10 litres of water, every 10 days
 - Rust: *Symptoms:* Brown pustules on leaves
Control: Use Dithane M45, at 30 g/10 litres of water, every 10 days

9.2. Groundnut

- Scientific name: *Arachis hypogea*
- Family: *Leguminosae*
- Cultivars: Long season variety: Flamingo
Short season variety: Nyanda and Falcon. These varieties are common on the Zimbabwe market
- Soil: Deep well-drained soils, pH 5.2-5.8. In lighter soils, kernels will be easy to lift and clean
- Climate: Summer crop, best planting in October-March
- Seed amount: 100 kg/ha
- Planting depth: 5-8 cm
- Spacing: Long season variety: 45 cm between the rows and 10-15 cm within the row. Plant population 125 000-150 000 per ha
Short season variety: 45 cm between the rows and 5-7.5 cm within the row. Plant population 250 000-300 000 per ha
- Planting time: Long season variety: end of September to early October in the Highveld; mid-October in the Lowveld
Short season variety: end of October to early November in the Highveld; mid-November in the Lowveld
- Growth period: Long season variety: 5-6 months
Short season variety: 3.5-4.5 months
- Fertilizers: *Basal application:* 400 kg/ha Compound S or Compound D
Top dressing: Nitrogen is not usually applied to groundnuts, unless it becomes very necessary during the early stages of growth. Gypsum to be applied at flowering on top of the plants at 200 kg/ha
- Harvesting: Harvest when 40% of the leaves are dry. Lift and leave pods to dry on racks
- Expected yield: 3 tons/ha
- Pests:
- Cutworms: *Symptoms:* Dying young shoots, cut at the groundlevel
Control: Apply Azodrin 40, at 20 ml/10 litres of water, or bait with Dipterex where these are a problem. Control as a routine faster seed emergence
 - Aphids: *Symptoms:* Sucking plant juice, making plants sticky, which attracts ants. The leaves start curling
Control: Apply Thiodan at 12 g/10 litres of water, or Dimethoate 40 EC at 10 ml/10 litres of water, when the first signs of the pest have been observed
- Diseases:
- *Cercospora* Leaf Spot and Rust: *Symptoms:* Brown or black circular spots on the leaves and elongated lesions on the petioles and stems. Rust is seen as rusty spots underneath the leaves
Control: When the frost symptoms are observed, use Dithane M45, at 20 g/10 litres of water, or Copper Oxychloride or Bravo

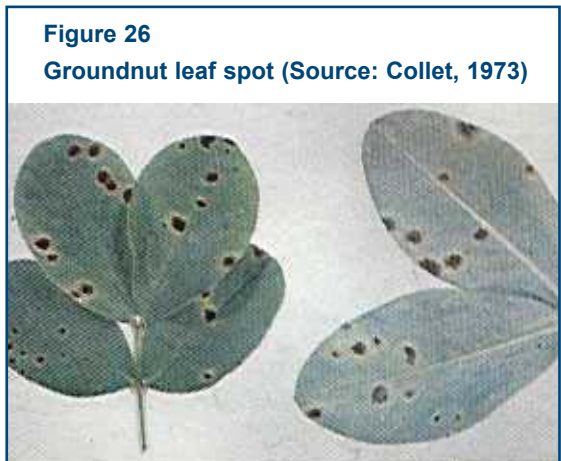

- Botrytis or grey mould: *Symptoms:* Grey sporing mycelia on stems, which will eventually wilt and die
Control: Use Bavistin, at 300-500 g/ha, once the disease symptoms have appeared
- Phoma, leaf or web blotch: *Symptoms:* Large grey to black spots on the leaves
Control: Use Dithane M45 or Bavistin

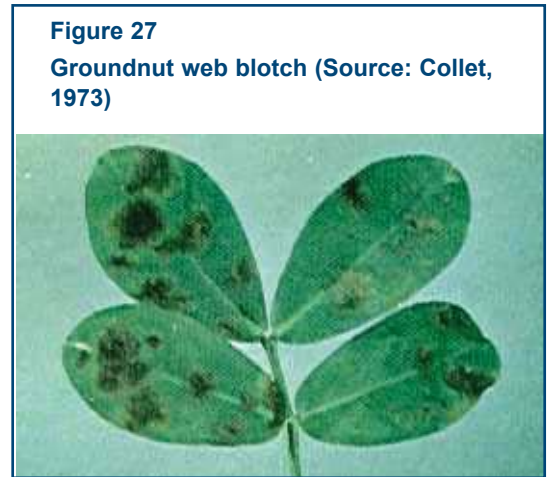

9.3. Maize

Scientific name: *Zea mays*

Family: *Graminae*

Cultivars: *Seed Co varieties:* Late maturity: SC 709, SC 713
Medium maturity: SC621, SC 625, SC627
Early maturity: SC501, SC513, SC515, SC 517, SC 521
Very early maturity: SC401, SC403, SC 405, SC 407

Pannar varieties: Medium maturity: PAN 473, PAN 35, PAN 31
Medium-late maturity: PAN 6243, PAN 6479, PAN 61, PAN 6777

All the above varieties are more common on the Zimbabwe market

Soil: Wide range of soils, well-drained, high organic matter. pH 5.0

Climate: Summer crop. Temperature range 10-30°C, optimum 20-24°C

Seed amount: Requires about 25 kg/ha, depending on seed size and on the plant population the farmer is aiming at

Planting depth: 5-7 cm. Presoaking the seed not only improves the germination percentage, but also reduces the days to seed emergence

Spacing: Long season varieties: 90 cm between the rows and 30-50 cm within the row. Put two kernels per station.
Plant population: 36 000-52 000 per ha
Short season varieties: 90 cm between the rows and 25 cm within the row.
Plant population: 36 000-60 000 per ha. The high populations are for irrigated crops

Planting time: Green Maize: In high altitude areas prone to frost, plant in mid-July when the threats of frost and cold are over
Grain Maize: Plant from August to October, depending on the coincidence of harvest and rainy season

Growth period: Green maize: Maximum 4 months
Grain maize: Long season varieties 152 days; medium season variety 148 days; short season varieties 126 to 137 days

Fertilizers: *Basal application:* 300 kg/ha of Compound D
Top dressing: 200-300 kg/ha of AN
It is important that the compound be placed below the seed. On heavy soils, top dressing with AN can be done once at knee high or 5 weeks after planting. On sandy soils the top dressing can be split twice at 5 weeks and 11 weeks after planting

Expected yield: 1-13 tons/ha, depending on cultivar, the availability of water for supplementary irrigation and production method

- Pests:
- Stalk borer: *Symptoms:* Windows or holes in the unfolding leaves from the centre
Control: Apply a few granules of Dipteres or Thiodan 1% G down each funnel about 4 weeks after germination
 - Aphids: *Symptoms:* Distorted growth, sugary appearance on the leaves and aphid presence
Control: Apply Metasystox 25% EC, at 40 ml/10 litres of water, full cover spray
 - Armyworm: Apply Carbaryl 85% WP, at 25 g/10 litres of water

Diseases: Leaf streak virus, Rust, Leaf Blight and Grey leaf spot are some of the most common diseases of maize, which cannot be controlled easily, except by using resistant varieties, crop rotation and hygienic practices.

9.4. Rice

Scientific name:	<i>Oryza sativa</i>
Family:	<i>Graminae</i>
Cultivars:	Check with the research institutions in the country
Soil:	Irrigated rice requires heavy soils with a low permeability so as to reduce water losses. Permeability can be reduced to a certain extent by intensive puddling of the soil. Rice has a high tolerance to acidity with optimum pH between 5.5 and 6. Rice is moderately tolerant to salinity. Yield decreases for different salinity levels are: 0% at EC _e of 3.0 mmhos/cm, 10% at EC _e of 3.8 mmhos/cm, 25% at EC _e of 5.1 mmhos/cm, 50% at EC _e of 7.2 mmhos/cm and 100% at EC _e of 11.5 mmhos/cm
Climate:	Temperatures should not fall below 10°C. Low temperatures during early growth stages result in a longer maturation period. Low temperatures during panicle initiation are especially harmful and may result in sterility of the grains (empty panicles). Temperatures between 22 and 30°C are required for good growth at all stages, but during flowering and yield formation small differences between day and night temperatures (up to 10°C) are conducive to high yields. Much sunshine, a slight wind and a fairly low relative air humidity will also lead to high yields. Dry weather during ripening and harvesting is essential for an even maturation of the crop and a low percentage of brokers
Seed amount:	80-100 kg/ha in case of direct sowing. 20-40 kg/ha when sown in nurseries for transplanting
Seedbeds:	Ratio of nursery : field is 1 : 20 to 1 : 30. Seeds are often pre-germinated, which involves soaking in water for 24 hours and subsequent germination for 24-48 hours
Transplanting:	Takes place when seedlings have 5-6 leaves (after 3-4 weeks)
Spacing:	Optimum spacing varies between 0.15 m x 0.15 m and 0.30 m x 0.30 m
Soil preparation:	The most important aspects of soil preparation are: the control of weeds; the creation of a good physical substratum for the crop; and sometimes a reduction of water seepage. Soil preparation can be carried out by hand (hoe), animals (plough) or tractor
Growth period:	From 90-210 days, depending on the variety, temperature and sensitivity to day length
Fertilizers:	Large doses of nitrogen, usually sulfate or ammonia or urea, are justified only in case of responsive high yielding varieties (HYV). During the sunny season, usually higher levels of N are applied than in the rainy season, when rice crop utilizes nitrogen more efficiently. The nutrients removed by a crop of 4 tons/ha of paddy are: 60 kg of N, 30 kg of P ₂ O ₅ and 30 kg of K ₂ O
Harvesting:	Smallholders usually harvest by hand, removing panicle by panicle, or alternatively by cutting the panicles of the whole plant with a sickle
Expected yield:	Under fully-controlled irrigation with high inputs: 6-8 tons/ha Under controlled flood irrigation good yields are 3-4 tons/ha
Pests:	<ul style="list-style-type: none"> • Stem borer: Of the <i>Tryporyza</i>, <i>Chilo</i> and <i>Sesamia</i> species, their larvae tunnel into the stems which finally die, resulting in complete sterile panicles (dead hearts) • Hoppers: Green leaf hoppers and brown plant hoppers, which suck the plants and may act as vectors of various virus diseases • Seed bugs: Sucking the seeds in the dough stage, resulting in empty seeds • Rats and birds: The latter especially are difficult to control
Diseases:	<ul style="list-style-type: none"> • Rice blast (<i>Piricularia oryzae</i>): A fungus disease which can show up in various growth stages (seedling blast, leaf blast and neck rot) <i>Symptoms:</i> Lesions on the leaves and empty head <i>Control:</i> Measures include early planting, avoiding excessive or high levels of nitrogen, proper flood management, resistant varieties, and fungicides. Varietal resistance is the most effective method of controlling rice blast. Some foliar fungicides can reduce the incidence of blast, but severe losses can occur on susceptible varieties even when fungicides are applied

Figure 28

Rice blast leaf lesions (Source: Texas A&M University, 2001)



- **Brown spot** (*Helminthosporium oryzae*): A fungus disease, especially in fields where growing conditions are poor. Significant development of brown spot is often indicative of a soil fertility problem
Symptoms: Brown lesions on the leaves
Control: Brown spot may be reduced by balanced fertilization, crop rotation, and the use of high quality planting seed. Foliar fungicides are not economical for controlling brown leaf spot on most commercial long grain varieties. Rice seed with infected glumes can result in diseased seedlings. Seed treatment fungicides reduce the incidence and severity of seedling blight caused by this fungus
- **Sheath blight** (*Corticium sasakii*): Causes the stem to rot near the water level
- **Rice yellow mottle virus (RYMV)**: Is the only known virus disease of rice in Africa, and it is indigenous to the continent. This relatively recent disease is limited to rainfed and irrigated lowlands and can be lethal to the infested plants if infection occurs early

9.5. Wheat

Scientific name: *Triticum aestivum*

Family: *Graminae*

Cultivars: Scan, Scholar, Scarlet, Shangwa, SC Nduna. These are all available on the Zimbabwe market

Seed amount: Depends on the method of sowing used. Broadcasting uses more seed: 130 kg/ha

Spacing: If using a drill, rows are spaced 30 cm apart

Planting time: May

Growth period: Most available varieties are of the spring wheat type, which takes 100-130 days to mature

Fertilizers: *Basal application*: 600 kg/ha of Compound C
Top dressing: 350 kg/ha of AN, applied twice during the first 8 weeks

Expected yield: 3.5-10 tons/ha

- Pests:
- **Quelia**: Weaver birds that are gregarious and feed on the grain. The Department of National Parks and Wild Life Management takes care of the control of very large colonies. For smaller colonies collective ground spraying should be organized
 - **Wheat aphid**: Light-green body with narrow dark-green longitudinal strip down the middle of its back
Small aphids sap-sucking on the under surface of the leaf
Symptoms: Development of black sooty mould growing on leaves, which is the result of sugar secretions by the aphids
Control: Spray Dimethoate, at 500 ml/ha, full cover spray
 - **Caterpillars, beetles, leaf-hoppers, termites**:
Symptoms: Lacerated leaves and stems, with holes
Control: Use suitable insecticide, for example Carbrayl, Malathion, etc.
- Diseases:
- **Stem rust**: Parasitic fungus damaging the plant by utilizing nutrients and water required for kernel formation. Enhanced by warm moist weather. Does not appear before end of July
Symptoms: Elongated red-brown, powdery pustules that develop on stems, leaves, leaf sheaths, awns and glumes. The pustules also perforate leaves
Control: Use resistant varieties. Do not sow before the 1st of May, because of risk of infection
 - **Leaf rust**: Appears earlier in the crop on the leaves and is followed by stem rust
Symptoms: Small circular orange-red pustules on the leaves and shoots. Pustules appear more on the upperside of the leaf
Control: As for stem rust
 - **Root rot**: Too-frequent irrigation combined with warm weather promotes the disease
Symptoms: Retarded growth, the crown and lower nodes turn brownish, root system poorly developed, brown lesions on the leaves and glumes, black point at germ end of the seed
Control: Observe a 3-year rotation with broad-leafed crops

Preparations necessary for marketing horticultural crops

The objective of growing vegetables or fruits is to make a profit. The farmer produces a crop that can be sold to their best advantage.

10.1. Characteristics of vegetables and fruits

10.1.1. Seasonality

In order to obtain maximum yields, each vegetable crop requires special climatic conditions to develop normally. According to geographic locations, favourable cropping periods vary in both their duration and their particular annual seasons. In areas where vegetable seasons are limited to one, there is always a case of excess produce on the market, followed by a shortage during off-season periods.

10.1.2. Susceptibility to damage

With the exception of some vegetable crops, like potatoes and mature bulb onions and fruits like avocados, most harvested vegetables and fruits are greatly subject to damage from mechanical shocks or climatic factors such as heat from the sun and cold. This sensitivity creates the need for a whole series of precautions in their handling, storing, packing and transport. Harvested crops must be treated very carefully if their appearance is to remain attractive and their internal composition undamaged.

10.1.3. Perishability

Vegetables and some fruits have a high proportion of water in their composition and this makes them easily subject to chemical and physical changes and hence to rapid deterioration. Maintaining their fresh condition under the climatic conditions of most African countries requires great care and a good practical knowledge of post-harvest physiology.

10.1.4. Diversity

The list of the various species and varieties of vegetables and fruits that can be grown is long. Each different species of vegetable crop or fruit needs its own special treatment for packing, storing and all other operations in preparation for the market. There are also different practices in the actual business of marketing. Some vegetables and fruits are sold by number, some by weight and others in bunches.

10.2. The Relationship between producer, distributor and consumer

To be successful, growing for markets must be based on economic realities and be capable of supplying cash to those involved. The final objective is to satisfy the needs, tastes and gastronomic habits of the consumer. To succeed, the producer of horticultural crops should have a perfect understanding of the qualities sought by all clients as far as the shape, size, colour, taste and consistency of all products are concerned. The farmers should choose varieties that best suit the market requirements. The nearer the farmer's produce approaches the qualities required by the consumer, the better their chance of obtaining the best price. Unfortunately, direct and regular individual contacts between producers and consumers are very difficult to establish due to the physical distances that separate them. Nevertheless, the producer should seek out such information during marketing.

10.3. Harvesting

Harvesting involves the separation of plants or plant organs from their natural support. This causes shock to the tissues, which causes physiological reactions with important effects on the future condition of the crop. The harvested crop must reach the consumer in as near a state as possible to the harvested crop. For this, the following must be observed:

1. Recognition of the point of optimum maturity is important for the successful harvesting of certain fruit and vegetable fruit crops, such as the tomato and watermelon. If such crops are harvested too early, the process of maturation is affected. If harvested too late, the ripening process is highly accelerated. For other vegetable crops, like fine beans and leafy vegetables, the degree of maturity is less critical. For these crops the ideal stage of harvesting is variable and depends on the taste and habits of the consumer served by the market concerned.
2. Correct handling is a very critical factor in the harvesting operation, because of the fragility and perishability of most vegetables. Picking or lifting of crops is best carried out manually, at least for those vegetables intended for consumption in a fresh state.

The personnel employed for harvesting should be selected according to their skill and dexterity. They should be trained to carry out their task delicately and rapidly. The grower must supervise the work and insist constantly that all rough handling is avoided. Every shock and small wound, even those not observable, will shorten the life of the vegetable or cause deterioration later. Such damage will reduce the quality and hence the profitability. Attention should be paid to the weather. Heat, rain and dew may all damage the appearance of the crop after picking or lifting. It is best to limit harvesting to fine mornings or cool evenings.

3. The use of suitable harvesting containers is very important in preserving the quality of the crop. It is convenient to use some type of field box or basket to collect the crop and carry it to a packing area before marketing. It is important that such containers are suited to the crop concerned and cause no damage to the crop. The containers must always be cleaned. Most smallholder farmers are still rather careless in this regard and use any old 5-kg boxes or 20-litres tins, which they never wash. Others use old baskets mended with iron wire, with points of wire sticking out in the interior.
4. Careful selection during harvesting is always required to avoid mixing bad and good produce. Diseased or damaged produce may infect the healthy produce. All malformed, immature and over-ripe material should be removed. Harvesting can be carried out in three phases. First, the complete elimination of all diseased or decayed produce that cannot be left on the plant or in the field. Second, the collection of all healthy produce of good quality and marketable. Third, the collection of produce of second quality with minor damage of blemish or other faults that reduces quality. This method reduces the grading process after harvest although it does require more labour.
5. A number of vegetables crops and fruits require a period of recuperation after picking or lifting, if they are to maintain their freshness and quality. Nearly all the fruit and vegetable crops like tomatoes, watermelons, fine beans, bananas, pome and stone fruits need a period of rest, which may vary in duration according to species. This means storing them for several hours in a cool, slightly humid, clean and fairly dark room, and immediately after picking. This rest period often results in the appearance of a few small bruises or wounds on some fruits that were not noticeable before. These can then be removed and the quality of the produce for the market is enhanced.

10.4. Storing the produce before marketing

In the case of perishable produce like fruits and some vegetables, storing is the preservation of the crop for shorter or longer periods crops under conditions that permit conservation of good external and internal quality together with all the characteristics required by the consumer. For the smallholder farmer storage under naturally ventilated conditions is the best. It is sometimes necessary to store produce for a considerable period, so as to space out the sales and avoid glutting the market. The site for the storage facility should be relatively elevated and well-exposed to the dominant winds. It can be located in the shade of a tree where there is a constant flow of relatively cool dry air. The design of the store should be simple and adapted to the climate. The crop should be spread on well-aerated open racks in a layer not exceeding about 20 cm in depth. The store must be kept clean and baskets and boxes packed so that they do not interfere with the free circulation of air. The material used to construct the building should be chosen from locally available material, within the means of the farmer.

10.5. Packing and grading

Packing concerns the preservation of the produce in the best possible conditions of freshness, appearance, hygiene and general attractiveness, hence protecting its market values. Absence of packing is a source of considerable losses, affecting the more fragile and perishable fruit and vegetable crops. When packing for the local market, the produce must be:

- ❖ Thoroughly cleaned
- ❖ Graded into two categories of quality
- ❖ Graded according to size
- ❖ Packed in boxes or baskets suitable for delivery to the market

When preparing produce for export to other countries, it is essential to be in possession of information on the current regulations. In many countries produce must now be packed in a certain way. In general the following treatments are required:

- ❖ Cleaning (washing, brushing and disinfecting)
- ❖ Pre-grading
- ❖ Quality grading
- ❖ Protection
- ❖ Size grading
- ❖ Packing export type and standard

10.6. Transport

Farmers should assess the transport and road conditions before setting up a horticultural production enterprise for the purposes of selling. In hot climates where the distances to be covered are long journeys that are undertaken in daylight, special protection and proper packing for the

produce is very necessary. Bad road conditions will inflict further damage on produce before it reaches the market. Frequency and reliability of transport as well as distances to the market should be assessed and planned for before the enterprise is established.

References

- Agritex. 1983. *Horticultural Handbook*. Internal Document (unpublished). Harare, Zimbabwe.
- Cassidy, M., Rice L.W., Nzima M.D.S. and Fenner R. Undated. *Tropical and subtropical fruit production in Zimbabwe*. Prepared and distributed by Horticulture Promotion Council. Harare, Zimbabwe.
- Collett, W.E. 1973. *Groundnuts in Rhodesia*. Department of Conservation and Extension. Salisbury, Rhodesia.
- Dodhill Nursery. undated. *Aspects of Citriculture in Zimbabwe*. Citrus short course (unpublished). Chegutu, Zimbabwe.
- Euroconsult. 1989. *Agricultural compendium for rural development in the tropics and subtropics*. Elsevier, The Netherlands.
- FAO. 1986. Yield response to water. *Irrigation and Drainage Paper 33*. Prepared by: J. Doorenbos, A.H. Kassam *et al.*, Rome, Italy.
- FAO. 1988. Vegetable production under arid and semi-arid conditions in Tropical Africa. *Plant Production and Protection Paper 89*. Rome, Italy.
- FAO. 1999. Vegetable seedling production manual. *Plant Production and Protection Paper 155*. Rome, Italy.
- FAO. 2000a. *IPM to IPMM?* By: Global IPM Facility. Rome, Italy.
- FAO. 2000b. *Summary of innovations in IPPM Field Schools: IPPM is not FOR farmers, it is BY farmers*. Prepared by: Kevin Gallagher, Global IPM Facility. Rome, Italy.
- FAO, Toxic Trail, Community IPM. 2002. *Community Integrated Pest Management*. <http://www.communityipm.org/ToxicTrail.htm>
- Forestry Commission. 1995. *Growing fruit trees*. Zimbabwe.
- Fresh Produce Producers Association. 1999. *Vegetable growers handbook*. A Commodity Association of the Horticultural Promotion Council of Zimbabwe.
- International Agricultural Centre (IAC). 2000. *International course on integrated pest management: strategies to control diseases, insect pests and weeds*. Wageningen, The Netherlands.
- Iowa State University. 2000. *Entomology Image Gallery*. Entomology Department. USA. <http://www.ent.iastate.edu/imagegal/>
- Lethève, X, Gova, M, and Mawere, G. Undated. *Important vegetable pests and diseases in Zimbabwe: Identification and control*. Agritex Horticulture Training Programme. Zimbabwe.
- Maynard, D.N. and Hochmuth, G.J. 1997. *Knott's handbook for vegetable growers*. John Wiley and Sons, Inc. Publishers.
- Nyanga Experiment Station. 1989-1995. *Annual Reports*. Horticultural Research Institute, Department of Research and Specialist Services. Zimbabwe.
- Our Garden Gang. 2002. *Plant problems and treatments*. <http://www.ourgardengang.trip.com>
- Parsons, B. Undated. *Grape production in Zimbabwe*. Prepared for Agritex. Zimbabwe.
- Purdue University 1993. *Vegetable insect identification*. Prepared by: Rick Foster and John Obermeyer. Department of Entomology. USA.
- Schippers, R. R. 2000. *African indigenous vegetables. An overview of the cultivated species*. Chatham; UK: Natural Resources Institute/ACP-EU Technical Centre for Agricultural and Rural Cooperation.

- Stocking, Michael and Murnaghan, Niamh. 2000. *Land degradation: guidelines for field assessment*. Overseas Development Group, University of East Anglia, Norwich, NK
- Texas A&M University. 2001. *Rice diseases*. Department of Plant Pathology & Microbiology.
<http://www.plantpathology.tamu.edu>
- University of Arizona. 2002. *Plant disease identification*. Extension Plant Pathology, Department of Plant Pathology.
<http://ag.arizona.edu/plpext/diseases/disease.htm>
- University of Florida. 2000. *Plant Pathology Guidelines for Master Gardeners*. Prepared by: Ken Pernezny, Gary Simone, Janice Collins, Richard Lentini. Institute of Food and Agricultural Sciences (IFAS). USA.
- University of Wisconsin. 2000. *Wisconsin's school integrated pest management manual*. Prepared by: John Stier, Karen Delahaut, Phil Pellitteri, Brian Backer. USA.
- Verkerk, Robert. 2001. *Farmers' friends: recognition and conservation of natural enemies of vegetable pests*. Field guide for extension staff and trainers in Zimbabwe. London, UK.
- Zimbabwe Farmers Union. 1997. *Horticultural handbook for small-scale growers*.