

Revised version

Training Manual
for
TSETSE CONTROL
PERSONNEL

Volume 3

REVISED VERSION

TRAINING MANUAL FOR
TSETSE CONTROL PERSONNEL

Edited by

J.N. Pollock, M.Sc. Ph.D.

V O L U M E I I I

Control methods and side effects

FOOD AND AGRICULTURE ORGANIZATION OF THE UNITED NATIONS

Rome 1986

TABLE OF CONTENTS

	Page
CHAPTER 1 - INTRODUCTION TO CONTROL METHODS	1
1.1 General principles	1
1.2 Eradication and control campaigns	2
1.3 Land use	3
CHAPTER 2 - CONTROL AND ERADICATION BY NON-CHEMICAL MEANS	5
2.1 Bush clearing	5
2.2 Game exclusion and game control	7
2.3 Control by traps (see also Vol. I, 7.2)	11
2.4 Biological control	11
2.5 Human settlements (see also Vol. II, 1.1.5)	13
CHAPTER 3 - INSECTICIDES USED IN TSETSE CONTROL	15
3.1 Types of insecticides	15
3.2 Purity of the chemical	16
3.3 Formulation	16
3.4 Labelling	19
3.5 Dilution	19
3.6 Quality control	22
3.7 Action of insecticides against tsetse	22
3.8 Safety measures	23
CHAPTER 4 - GROUND SPRAYING AND SURVEYS	26
4.1 General principles of ground spraying	26
4.2 Insecticides and safety	27
4.3 Equipment, repair and maintenance	30
4.4 Spraying programmes (West Africa)	40
4.5 Spraying programmes (Southern/Central Africa)	62
4.6 Ground spraying of persistent insecticide from tractor operated pumps	70

4.7	Placement and spraying of artificial screens (targets)	75
4.8	Survey methods	81
CHAPTER 5 - CONTROL AND ERADICATION OF TSETSE BY AERIAL SPRAYING (AND FOGGING)		91
5.1	Introduction	91
5.2	Aircraft and the main types of aerial spraying	91
5.3	Fixed-wing aerial spraying using non-residual techniques	92
5.4	Fixed-wing aerial spraying using residual insecticides	103
5.5	Helicopter application of non-residual insecticides	103
5.6	Helicopter application of residual insecticides	104
5.7	Fogging	106
CHAPTER 6 - OTHER POSSIBLE EFFECTS OF INSECTICIDES USED IN TSETSE CONTROL		107
6.1	Areas at risk	107
6.2	Known ways in which insecticides can be dangerous to man	107
6.3	Danger to wildlife (see Table 6.1)	108
6.4	Possibility of recovery of environment after damage	108
6.5	Monitoring the environment	110
CHAPTER 7 - INTEGRATED CONTROL		121
ACKNOWLEDGEMENTS FOR MAPS AND FIGURES		123
RECOMMENDED READING		124
APPENDIX I	- CLASSIFICATION OF ANIMALS MENTIONED IN THE MANUAL	126

APPENDIX II	- COMMON NAMES AND SCIENTIFIC NAMES OF SELECTED AFRICAN WILD MAMMALS	129
APPENDIX III	- BITING FLIES OTHER THAN GLOSSINA	131
CONVERSION TABLE		133
GLOSSARY		134

CHAPTER 1

INTRODUCTION TO CONTROL METHODS

1.1 GENERAL PRINCIPLES

There are many different ways of attacking tsetse flies. The more important of these methods are described in detail in other chapters of this volume.

The commonest method used in the past was to cut down the woody vegetation which provides the shade and resting places necessary for the fly.

Today, the commonest method is to use insecticides, applied either from the ground or from the air.

With ground application, the aim is normally to place droplets of insecticide on the parts of the vegetation used by tsetse for its resting places. When the spray dries off, a thin film of insecticide is left which is enough to kill the tsetse if it settles on it for a few minutes.

The insecticide has to be long-lasting (persistent) to give a chance for tsetse in the area to settle on the insecticide deposits.

The insecticide must also last long enough for all the tsetses that are in the pupal stage at the time of spraying, to change into flies and land on the sprayed vegetation.

With aerial application, the aim may be

- a) to spray a persistent insecticide on the vegetation in the same way as just described, or
- b) to spray a fine mist of very small insecticidal droplets (aerosol spray) which kills the flies by direct contact. The insecticide does not persist, so there has to be

repeated applications (roughly every 2-3 weeks) over the whole area, so that flies newly emerged from pupae are killed before they have a chance to reproduce. These repeated applications continue until all the pupae have changed into flies. Four to six applications are normally required.

Careful ecological studies are necessary before deciding which is the best method or methods to use in a particular area.

1.2 ERADICATION AND CONTROL CAMPAIGNS

Measures against tsetse can aim at either eradication or control.

1.2.1 Tsetse eradication For tsetse eradication, all flies in an infested area are killed. Flies from outside an eradication area are prevented from entering the area by making sure it is naturally isolated from nearby infested areas, by making cleared or insecticide barriers to achieve artificial isolation or by developing the area in such a way that it is no longer a suitable habitat for tsetse flies.

Eradication is often difficult to achieve. It is easiest when an area infested by tsetse flies is not too large and is naturally isolated from other infested areas.

Detailed aerial and ground surveys are necessary before deciding whether an infested area is suitable for an eradication attempt. Where the costs are too great or the land is not suitable for agricultural development, it may be necessary to decide against starting an eradication campaign in that area.

Where it is possible, eradication is much cheaper than continual tsetse control, as it is usually necessary to use insecticides once only (or occasionally 2 or 3 times).

Eradication therefore may be less harmful to the environment than control measures which rely on repeated spraying.

Survey must be continued for some years after an eradication campaign to ensure the area remains fly free.

1.2.2 Tsetse control To achieve control, as opposed to eradication, enough flies should be killed in a tsetse infested area so that man and his domestic animals can live there without much danger of them becoming infected with trypanosomes. Control work may have to be repeated at regular intervals, usually at least once a year, in order to keep fly numbers low, and hence the disease challenge at a low level.

Regular control may not be difficult but it can be very expensive. Regular use of insecticide can be harmful to the environment and might even eventually result in the development of insecticide resistance by the local tsetse flies. Because of these problems, very careful studies must be made before deciding to start tsetse control operations.

If the objective is to control sleeping sickness by reducing fly numbers, considerations of cost are relatively unimportant.

If the objective is to control animal trypanosomiasis by reducing fly numbers, considerations of cost are very important. Benefits resulting are often less than the cost of continued control, particularly if the control area is surrounded by infested areas.

1.3 LAND USE

Governments should make plans to ensure that land to be cleared of tsetse flies is used as efficiently as possible. Different types of tsetse-infested land are suitable for different uses after tsetse flies have been removed, but:

- a) insecticides do not permanently alter the tsetse habitat and if the cleared land is not settled by people or developed in some other way there will always be a risk of re-invasion by tsetse,
- b) if too many cattle move into a cleared area, overgrazing will occur and soil erosion may also take place.
- c) if too many people move into the area to make farms, then the land cleared for the use of cattle will be lost.

In order to prevent these mistakes it is essential to make certain that plans for the best use of land reclaimed from tsetse can be enforced by Government and local authorities.

While it is important that Governments plan land development and reclamation, it is also important that local people should help in deciding how best to use their land. Foreign methods of farming and keeping livestock will not necessarily work following tsetse eradication or control in underdeveloped areas; it is usually better to aim at the improvement and expansion of local traditional methods.

CHAPTER 2

CONTROL AND ERADICATION BY NON-CHEMICAL MEANS

2.1 BUSH CLEARING

If there are no trees or bushes growing in an area, then it is nearly always impossible for tsetse to live there permanently.

Cutting down the bush removes the resting sites of tsetse, where it normally finds cool shade and humidity.

Bush clearing as a method of tsetse control has been in use for a long time, but was commoner in the past than it is now because of the rising cost of labour. It is suitable for relatively small areas.

In planning a bush clearing exercise, there should be close consultation with the Agriculture, Forestry and Land Use Planning departments.

Bush clearing may take the form of total or sheer bush clearing, or partial bush clearing (in which only part of the woody vegetation is removed).

2.1.1 Total or ruthless bush clearing This has been carried out for the following purposes:

- a) To make a treeless area as a barrier against the spread of tsetse (see 2.2.2).
- b) To prevent tsetse from coming near to main roads and cattle routes (corridor clearing).
- c) To cut off a convenient-sized tsetse-infested area for later experimental or control work.
- d) To protect villages having a bad record of sleeping sickness, from tsetse in the surrounding bush.
- e) To protect important fords and watering places in Gambian sleeping sickness areas.

Method: All trees, bushes and thickets are cut down to below knee height and burned.

Alternatively, the trees etc., are stumped, that is, the roots are pulled out or dug up and burned. This is a much slower and more expensive exercise, but reduces the amount of regrowth.

Normally, regrowth will have to be slashed down every two or three years.

Cutting may be by hand axes or power saws. Where the land and the finance allow it, tractors dragging heavy chains between them can be used to rip up trees and bushes. This expensive equipment can only be used where there is a very large programme, fairly flat land, and efficient technical workshops available.

Usually, hand axes are the most practical method.

If possible, the timber cut down should be used for sale as firewood, charcoal or for construction, and the land cleared should be used for growing crops.

Arboricides (tree poisons) may help to reduce the amount of regrowth, but the cost of their use should be carefully watched. The ability of trees to grow new shoots in spite of treatment with arboricides may vary from place to place, so special tests should be carried out in each area where their use is planned.

In the case of hand clearing, the work force may be split up into gangs, each under a foreman. Teams of workmen may be allotted an area to clear, the size of the area depending on the amount of timber to be felled. Exceptionally hard-timbered trees may have to be burned away slowly by piling firewood around the base. Firewood should be burned around remaining stumps to discourage regrowth.

Careful maps should be kept showing cleared areas with dates of the work. It is particularly useful if the maps show the number of man-days and the cost in money, of each part of the operation. Costs will vary greatly according to the thickness of the vegetation.

2.1.2 Partial bush clearing This may be of two sorts:

- a) Discriminative bush clearing, in which parts of the vegetation are cut down, such as dambo (mbuga) edges, or patches of woodland thought to be concentration areas of tsetse.
- b) Selective bush clearing in which particular species of trees are removed, leaving the remainder.

There may not be a great difference between the final results of these types of partial clearing.

In the dry savanna zone of West Africa, riverine tsetse used to be controlled by cutting down the small trees and shrubs along the riversides, leaving the taller trees with clean boles (trunks).

Cutting away this undergrowth allows dry air to get to the river bank, and can make the habitat unsuitable for Glossina tachinoides and G. palpalis.

Re-invasion of the cleared areas may be prevented by making a total (sheer) clearing 2 km. long at the downstream limit of the area in which partial bush clearing has been carried out.

This method of attack is more likely to be successful in the more northerly areas where the climate is severe, than further south where the climate is milder.

Partial clearing is being replaced by insecticide spraying, but total clearing may still be done to prevent re-invasion from outside the sprayed area.

2.2 GAME EXCLUSION AND GAME CONTROL

2.2.1 Removal of game will help to control tsetse
Tsetse depend mainly on game animals in order to feed. This is especially true of the morsitans group.

The destruction of game animals would remove all or much of the food source of tsetse, and at the same time remove the main reservoir of cattle trypanosomiasis and of Trypanosoma rhodesiense.

From practical experience, it is known that removal of the game animals removes the fly. The rinderpest epidemic greatly reduced the game animal population of Africa: a great reduction of the tsetse belts occurred at the same time. Recovery of the animal population later allowed the recovery of the fly infestation.

A major game destruction exercise in Zimbabwe successfully stopped an advance of G. morsitans spreading after the rinderpest outbreak had passed.

Later, another campaign in the same country cleared tsetse from a G. morsitans-infested area by the method of game destruction.

Uganda, and to a lesser degree Sudan, have had highly organized game control schemes aimed at eliminating tsetse.

However, there is strong public pressure to conserve game rather than destroy it, and the method is not recommended.

2.2.2 Game elimination and 'game-proof' fences

Attempts have been made to set off parts of the country to be reserved for game, other parts being for cattle, with a holding line in between these two areas. The holding line (see 2.2.3) normally consists of:

- a) a game fence
- b) a strip of country completely cleared of bush and game
- c) a wider strip of country not cleared of bush but cleared of wild game, as far as possible, using hunters.
- d) a stock fence.

A properly maintained holding line would present a barrier to tsetse advance, because there would be a wide area in which no food could be obtained.

There are practical problems to the use of holding lines:

- i) The game fence cannot be made fully game-proof. Small animals, such as the smaller antelope, can step through the fence. Larger animals, such as the bush-pig can find places where there is a gap beneath the lowest fence wire for them to pass. The big game animals, such as elephant and buffalo, will not be stopped by a standard game fence, but will push over the fence posts, or push down the wire. Large antelope may be able to jump over the fence.
- ii) All game cannot be eliminated. For a reasonable cost it is not possible to shoot out all the animals between a game fence and a stock fence.
- iii) Holding lines cause damage to wild life, without necessarily succeeding in tsetse control.
- iv) Tsetses (G. morsitans) can exist in areas where game is rare or practically absent (e.g. parts of northern Nigeria).
- v) A severe climate may be required for a game-destruction experiment to be effective in eliminating tsetse. The Zimbabwe successes were achieved in areas in which the climate in the winter months was almost too cold for the survival of Glossina. Similar success may not always follow in milder climates.
- vi) Holding lines are costly to build, maintain and supervise. The effectiveness of holding lines is at present under study.

2.2.3 Specifications for holding lines The following holding lines are in use in Zambia:

- Game fence: Height 1.9 m.
 Wire (454 kg. breaking strain), 7 strands at the following heights above the next wire (or ground level in the case of the first one):
 15 cm., 23 cm., 23 cm., 23 cm., 23 cm., 38 cm., 46 cm.
 Posts 2.7 m long, of which 0.76 m is buried in the ground. Posts set at 20 m. intervals
 Droppers (poles not fixed to ground). Two between posts.
 Strainers at 400 m. intervals.
- Stock fence: Height 1.5 m.
 Wire, soft, 5 strands at 30 cm. apart.
 Posts 2.1 m. long and less robust, of which 60 cm. is buried.
- Game-free and stock-free zone between game fence and stock fence:
 Width 5 km.
- Clearing: Width 1 km.;
 400 m. on infested side of game fence
 600 m. on protected side.
 Clearing by felling and burning, no stumping.
- Pickets: Set up at points along the fence where roads etc. cross, to defly traffic.

2.3 CONTROL BY TRAPS (see also Volume I, 7.2)

Sticky screens, Harris traps, Morris traps sprayed with D.D.T., animal hides sprayed with D.D.T. or B.H.C., have all been used in campaigns to eradicate fly from local well-defined belts.

Some control (not eradication) of tsetse can be had by using blue screens sprayed with persistent insecticide (e.g. decamethrin 75 mg. a.i./m² of screen surface). Five to ten of these screens per hectare are placed in the area of the infestation (forest zone).

Challier-Laveissière biconical traps may also be able to cause a significant reduction in the numbers of tsetse in an area.

Sticky traps were used to help clear Principe Island of Glossina palpalis.

However, much more research work is required to improve the efficiency of traps. The numbers of flies removed by trapping can rather quickly be replaced by immigration of flies from outside the area. Electric traps are at present much too expensive to use on a large scale.

2.4 BIOLOGICAL CONTROL

2.4.1 Need for biological control methods There are definite problems in using powerful poisons (insecticides) to eradicate tsetse. There is always the danger that the environment may become seriously affected, or that the tsetse may become resistant to the insecticides, or that other unexpected side-effects may occur.

A number of alternative methods of control are grouped under the heading biological control. All are at an experimental stage only.

2.4.2 Use of predators and parasites Details of parasites and predators of tsetse are given in Volume II, 1.1.4.2.

In some tsetse habitats, parasitic insects, such as Syntomosphyrum and Mutilla (both Hymenoptera) and Thyridanthrax (Diptera), may play an important part in controlling the size of tsetse populations. Experimental release of large numbers of parasites have never caused lasting control of tsetse.

Disease-causing organisms, such as fungi, Protozoa, bacteria, viruses and mermithid nematodes, have been found living in or on tsetse flies. While certain bacteria and viruses have been used to control other insect pests, little is known about their effectiveness against tsetse in the field.

2.4.3 Sterile male release technique This method has been used with success against other insect pests.

By this method large numbers of male flies are sterilised and released into the field. They mate with wild virgin females which store the males' sterile sperm within themselves. As a result, the eggs of the females fail to become fertilized so no further development can take place.

Pupae or young adult males are sterilized by irradiating them from a radio-active source (or by contact with sterilising chemicals).

The technique also requires:

- a) methods for the cheap mass-rearing of tsetse flies
- b) the sterilised males to be as able as ordinary wild males to mate with wild females
- c) efficient methods of handling and releasing flies in the correct habitats.

It is expected that in any eradication campaign a sterile male release will take place immediately after a tsetse population in the field has been reduced in numbers by an insecticide spraying exercise. The released males will then seek out the rather few remaining females and mate with them, leading to the failure of these surviving females to reproduce.

A lot of the background information is now known; for example, how much irradiation is needed, how tsetse flies can be bred on a fairly large scale, and how flies can be handled.

Two experimental (pilot) sterile male release programmes have already made progress. One was in Tanga, Tanzania, (against G.m. morsitans) and the other is at Bobo Dioulasso, Upper Volta, (against G. palpalis gambiensis). Recently a third programme has been started in Nigeria (against G.p. palpalis).

2.4.4 Other genetical methods Cross mating of closely related tsetse species results in sterility of the hybrids. This has been considered as a possible means of control, but work is at a very early stage and there is no field scheme on the scale of the sterile male release programmes nor is there likely to be in the near future.

2.5 HUMAN SETTLEMENTS (see also Volume II, 1.1.5)

Villages may have to be evacuated because of the threat of sleeping sickness. There are many examples of this, in which people are directed to move away from their original settlements to places where the risk of sleeping sickness is much less. An important early example was the removal of the human population living along the shores and on the islands of Lake Victoria (1906) to places inland, away from the source of Gambian sleeping sickness. Another example was the Anchau Settlement Scheme of Nigeria, in which communities were moved to planned 'model' villages in areas cleared of tsetse. In Rhodesian sleeping sickness areas small villages (family settlements) scattered in the remote bush are much more at risk than large villages. If villages can be persuaded to live in larger groups the threat of sleeping sickness would be much less. But it can be very difficult to get the agreement of villagers to take part in such schemes. They have their own good reasons for preferring to live where they do, but these reasons may not be obvious to the adviser from outside.

The new settlements that are set up must not be too large for the fertility of the land to support. Departments of Agriculture, Fisheries, Water Resources, and Land Use should be fully consulted. In some areas of Tanzania, Sleeping Sickness Settlements of 2600-3500 people have been set up in the past, increasing the density of the population from about 6 people/km² to about 38 people/km². The new settlements may be in tsetse free areas, or in marginal areas where it is expected that the increased agriculture will make the place unsuitable as a tsetse habitat.

CHAPTER 3

INSECTICIDES USED IN TSETSE CONTROL

3.1 TYPES OF INSECTICIDES

Four types of chemical compounds are, or have been used in tsetse control as insecticides experimentally or in practical campaigns:

- a) Organochlorines: e.g. D.D.T., B.H.C., dieldrin, endosulfan (= thiodan).

These have a high chlorine content. They are soluble in organic solvents including fats, but are much less soluble in water. Some can persist for a long time in the environment, and in the bodies of animals (especially in the fat).

Endosulfan is an exception, as it breaks down more quickly than the other organochlorines used in tsetse control.

- b) Organophosphates: e.g. fenitrothion, jodfenphos, tetrachlorvinphos, fenthion, azamethiphos.
- c) Carbamates: e.g. carbaryl, bendiocarb, propoxur.

Both organophosphates and carbamates will chemically react with water, and break down as they do so. They are broken down by the action of ultra-violet rays from the sun. They also pass into the atmosphere as a gas more easily than the other insecticides.

- d) Pyrethroids: e.g. resmethrin, permethrin, deltamethrin.

The manufactured (synthetic) pyrethroids are persistent in air, in light, and do not easily change into a gas. They are fairly new, and are still being tested against tsetse in the field.

In general the pyrethroids are the most poisonous (toxic) for tsetse, followed in order by organochlorines, organophosphates, and carbamates. The last two types are not used against tsetse in campaigns.

The choice of insecticides for use in tsetse control will depend on

- a) their toxicity to tsetse
- b) their cost
- c) how the insecticide is to be used
(as a residual insecticide, or as a space spray)
- d) their effect on other organisms.

3.2 PURITY OF THE CHEMICAL

Several insecticides as used are mixtures of slightly different forms of the same chemical. These different forms are called isomers, and they may have different effects as insecticides.

For example, D.D.T. is a mixture of isomers. One, called the parapara isomer, makes up 70% of the total and is the most active as an insecticide. The others are less active as insecticides.

Endosulfan also has two isomers, one of which is more effective than the other.

Permethrin also has different isomers, and the proportions of the different isomers may differ according to the manufacturer, and according to the use for which the permethrin is being made.

3.3 FORMULATION

In order to apply the insecticide effectively, it has to be mixed with other materials so that it can pass through the machines used for spraying and reach the target area in the right amounts.

The exact concentration and mixture of substances present in an insecticidal material as purchased is called the formulation.

The insecticide normally comes from the manufacturer in a formulation ready to be used.

There are three main types of formulation:

- a) Water dispersible powders (W.D.P.) = wettable powders (w.p.)
- b) Emulsifiable concentrates (e.c.)
- c) Liquid concentrates
- d) Suspension concentrates.

3.3.1 Water dispersible powders A W.D.P. (or w.p.) consists of:

- a) the active ingredient (the insecticide itself)
- b) an inactive (inert) material such as clay or silica
- c) a dispersant which causes the mixture to spread evenly throughout the water in which it is shaken.

The aim is to make a mixture suspended in water so that after spraying, a thin film of powder containing the right amount of insecticide (e.g. D.D.T.) lies on the treated surfaces. An insect will then pick up a lethal dose as it rests upon or moves over the treated surface.

Wettable powders leave a whitish deposit on the trees, etc., on to which they are sprayed. These whitish marks allow the team leaders to judge whether the spray has been applied to the correct parts of the vegetation.

Very old stocks of insecticide may have lost their ability to mix well with water. If so, they will be almost useless.

3.3.2 Emulsifiable concentrates An e.c. consists of:

- a) the active ingredient
- b) a solvent that does not dissolve in water
- c) a dispersant that causes the active ingredient plus solvent to make a stable mixture (emulsion) with water.

The aim of spraying is usually to make droplets of the required size, containing the required amount of insecticide.

In ground and helicopter spraying the insect will pick up a lethal dose (e.g. of dieldrin) as it rests on the treated surface.

3.3.3 Concentrates for fixed-wing non-residual aerial spraying These are often used for making very small droplets from aircraft. A cloud of very small droplets is called an aerosol.

Concentrates that are applied at very low dosages are called ultra low volume (U.L.V.) formulations. Endosulfan can be used in this way.

Solid insecticides normally have to be dissolved in a solvent, to keep them in liquid form until they make contact with the insect target.

Examples of solvents that are used are kerosene, shellsol, diesel (all these will gradually evaporate). Vegetable oils may be used with these solvents, to reduce the rate at which they evaporate.

The solvent (or combination of solvents) to be used will also depend on the spray apparatus.

Solvents are also important because they can make the insecticide pass more rapidly through the cuticle of the insect (or through the human skin, see 3.8). The tsetse is killed by small concentrated droplets of the insecticide coming directly into contact with it.

3.3.4 Suspension concentrate This unusual formulation is in use for deltamethrin.

3.4 LABELLING

All containers of insecticides should be clearly labelled with:

- a) the common name of the active ingredient (even though the manufacturer may already have put on his own trade name)
- b) the concentration of the active ingredient (so that the proper dosages, dilutions and applications can be made).

For W.D.P.s (w.p.), it is usual to write the concentration as percent weight/weight (%w/w) or as grams/kilo. Thus 1 Kg. of 50% w/w, contains 500 g. of active ingredient (a.i.).

For e.c. and liquid formulations, the concentration is expressed as percent weight/volume (%w/v), or grams per litre. Thus 1 litre of 50% w/v contains 500 g. a.i.

3.5 DILUTION

3.5.1 Definition Wettable powders when mixed with water form a suspension. Emulsifiable concentrates when mixed with water form an emulsion.

Suspension: fine particles of powder are suspended (held) in a large amount of water.

Emulsion: tiny droplets oil-based of liquid insecticide are suspended in a large amount of water.

In both cases, the mixture is not stable. It is necessary to stir the mixture frequently before using it to fill spraying machinery.

3.5.2 Calculations

- (a) to calculate the amount of water required to make a required dilution of a wettable powder
- (i) note the concentration of the powder (50% a.i. for example)
 - (ii) note the concentration it is required to make the spray liquid (5% for example)
 - (iii) divide the smaller by the larger:

$$\frac{5}{50} = \frac{1}{10}$$

This gives the number of kg. that have to be added to 1 litre of water to give the required dilution.

In this case it is $\frac{1}{10}$ kg.

If, for example, 200 litres of spray liquid are being made, then $200 \times \frac{1}{10}$ kg. = 20 kg.

of wettable powder are required to be added to the 200 litres of water to make 200 litres of 5% spray liquid. (When mixing D.D.T. wettable powder with water, the volume of the powder itself is very small compared with that of the water, and can be ignored).

- b) To calculate the amount of water required to bring about a required dilution of an emulsifiable concentrate (e.c.)
- (i) note the concentration of the e.c. (20% a.i. for example)
 - (ii) note the concentration it is required to make the spray liquid (4% for example)
 - (iii) divide the larger by the smaller and subtract 1:

$$\frac{20}{4} - 1 = 4$$

This gives the number of litres of water (4) that should be added to 1 litre of e.c., to make the required strength of spray liquid.

In this example, 5 litres of spray liquid are made. So 4 litres of water are added to 1 litre of e.c. to make 5 litres of spray liquid.

If 200 litres of spray liquid are being made, then the amounts of the e.c. and of water have to be multiplied by 40, so that 160 litres of water must be added to 40 litres of 20% e.c. to give 200 litres of 4% spray liquid.

Other examples:

Formulation	Water to be added (litres)	Amount of powder or concentrate to be used	Amount of spray liquid made (litres)	Concentration of spray liquid made
w.p.75% a.i.	200	13.3 kg.	200 (approx)	5%
	200	10.7 kg.	200 (approx)	4%
	200	8 kg.	200 (approx)	3%
w.p.50% a.i.	200	20 kg.	200 (approx)	5%
	200	16 kg.	200 (approx)	4%
	200	12 kg.	200 (approx)	3%
e.c.30% a.i.	173.3	26.7 l.	200	4%
	180	20 l.	200	3%
	186.7	13.3 l.	200	2%
e.c.20% a.i.	160	40 l.	200	4%
	170	30 l.	200	3%
	180	20 l.	200	2%

3.6 QUALITY CONTROL

Making sure that the right insecticides of the right specifications are ordered is the responsibility of headquarters.

Insecticides in store should be used before starting on a new consignment (first received should be used first). Leaking drums should be used immediately or the contents transferred to sound drums.

Consignments should be stored in cool shady areas, under cover.

3.7 ACTION OF INSECTICIDES AGAINST TSETSE

3.7.1 Toxicity The poisoning effect (toxicity) of different insecticides to tsetse varies.

For example:

- a) the toxicity of dieldrin to tsetse is 10 times that of D.D.T.
- b) the toxicity of endosulfan to tsetse is 14 times that of D.D.T.
- c) the toxicity of some synthetic pyrethroids to tsetse is much greater than these other insecticides.

If an insecticide kills individuals of an insect species then these individuals are said to be susceptible.

Pregnant females of Glossina are about 9 times less susceptible to organochlorine insecticide than young males.

Fertilized (but not pregnant) females of Glossina are about 4 times less susceptible to organochlorine insecticides than young males.

These facts should be remembered when carrying out post spray surveys. Females are more likely to survive a spraying operation, but are less likely to be detected by an ordinary fly round or survey using hand nets.

3.7.2 Specificity Ideally, an insecticide should be very toxic to the insect being controlled (in this case Glossina) and yet harmless to all other (non-target) organisms.

Fortunately, Glossina is much more susceptible to organochlorine insecticides than many other insects are, for example Musca.

Even so, the amount of insecticide that has to be sprayed is large, and can have harmful effects on other organisms.

For example, dieldrin spraying can cause deaths of birds (especially insect-eating birds) and fish, as well as a wide variety of other organisms.

3.7.3 Resistance Many agricultural insect pests have become resistant to insecticides. This means that the pests survive insecticide dosages that at one time would have been lethal to them.

When resistance develops, more of the insecticide has to be used, or the type of insecticide has to be changed or the spraying method altered. All these are serious problems, causing the loss of time, money and effort.

So far, resistance has not been reported in Glossina, but research is in progress to test if populations exposed to insecticides are developing resistance.

3.8 SAFETY MEASURES

Insecticides should always be treated with great care.

The Team Leader should make certain that the safety rules laid down are obeyed.

- a) Do not allow insecticide to enter the mouth.
- b) Always wash the hands and face carefully before eating, drinking or smoking. Hands and face should be washed frequently each day.
- c) Wash the whole body with soap and water after the end of the day's work.
- d) Wash working clothes every day.
- e) Water used for washing to be drained into a pit.
- f) Prevent insecticide getting into contact with food, either in camp or in the vehicle.
- g) Do not handle insecticide with bare hands. Use a stick to stir up a spray liquid.
- h) Do not allow insecticide to come into contact with eye, mouth or nose. Wash with plenty of water if this does happen.
- i) Avoid careless spraying that might contaminate a worker (e.g. spraying into a strong wind, or spraying with spray operators too close together).
- j) Vehicles used for carrying insecticides should be thoroughly washed down after use.

When the more dangerous emulsifiable concentrates are being handled, the following extra rules must be obeyed.

- a) For handling and mixing emulsifiable concentrates, gloves, face mask and goggles must be worn as well as overalls and boots.
- b) Wash the skin immediately with plenty of clean water if any concentrate comes into contact with it. Soap and clean water should always be available at the mixing site.

Symptoms of organochlorine poisoning:

Light doses:

- a) Skin itching at the point of contact with insecticide.
- b) Hearing and vision defects (sounds may seem too loud, and colours too bright).
- c) Headaches and dizziness.

Heavier doses:

- d) Clumsiness (lack of co-ordination of limbs),
- e) Collapse,
- f) Convulsions (as in epilepsy), grinding of teeth, trembling.
- g) Too much salivation (dribbling, frothing at the mouth) nausea, constipation.

The worst effects of poisoning last 2-5 hours after contact with insecticide. The milder effects can last several days.

Treatment of organochlorine poisoning.

- a) If poisoning was through the mouth, force the patient to vomit, by putting a finger to the back of the throat, or by giving a dose of salty water.
- b) If poisoning was through the skin, the patient should immediately wash the area very thoroughly and repeatedly.
- c) If the patient is suffering from headaches, dizziness or any other of the signs of poisoning listed above, he should be taken to a doctor immediately. The doctor should be informed which insecticide has caused the poisoning, as the treatment depends on the type of insecticide. Doctors working in the spray area should have been warned of the use of insecticides in their districts.

CHAPTER 4

GROUND SPRAYING AND SURVEYS

4.1 GENERAL PRINCIPLES OF GROUND SPRAYING

4.1.1 Spraying the natural resting sites of tsetse

The aim is to place a persistent insecticide on to the natural resting places of tsetse, so that flies are killed if they settle on the deposit.

The spray droplets have to be sufficiently large to give a heavy deposit on the sprayed surface.

Spraying is nearly always carried out in the dry season. If there is rain or the threat of rain, work should be stopped for 24 hours.

DDT and dieldrin have been used for this work. Dieldrin persists better than DDT in humid or wet conditions and must be used if (in an emergency) spraying has to be attempted in the rainy season.

The insecticide deposit must last at least two months after a single application because:

- a) pupal life may last about 4 weeks, so that newly emerged flies will continue to appear for that interval of time,
- b) a large area cannot be sprayed all at once: a short-lived insecticide deposit could not kill flies entering a cleared area before their own habitats were sprayed.

Spraying may be total or selective.

Ruthless (blanket) spraying is carried out to make chemical barriers preventing re-infestation of cleared areas.

Selective spraying is used wherever possible. It requires exact knowledge of the flies' resting places, and of tsetse ecology.

The aim is to place insecticide only where it is likely that tsetse will rest. This method saves costs and keeps contamination of the environment to the minimum.

4.1.2 Spraying insecticides on the screens (targets)

The aim is to erect insecticide-impregnated cloth screens in the habitat of the fly. The screens are attractive to fly because of their colour (black or blue). In campaigns against certain species (especially Glossina pallidipes and G. morsitans) the screens are made more attractive still by the addition of special odours.

The screens (often called targets) are sprayed with insecticide, usually deltamethrin. Re-spraying may be required every one or two months, according to circumstances.

Effect on the general environment is very slight, as the insecticide is applied only to the screens.

The method is likely to become increasingly important in the future, as techniques are improved by further research.

4.2 INSECTICIDES AND SAFETY

4.2.1 Insecticides and formulation. For ground spraying on to natural resting sites, there is a choice at present between D.D.T. and dieldrin.

Dieldrin is more hazardous to use than D.D.T.

- a) Dieldrin insecticide itself is more poisonous than D.D.T.
- b) Dieldrin comes as an emulsifiable concentrate, which is much more dangerous to handle than wettable powder (D.D.T.), because the solvents help dieldrin to pass through the human skin.

Most other insecticides are not sufficiently persistent under field conditions for use as deposits on resting sites.

Newer and safer insecticides are being tested for use with cloth screens in tsetse control and some show promise, for instance deltamethrin.

This is extremely toxic to tsetse flies, and therefore can be used in very low concentrations in the field. It has low mammalian toxicity.

4.2.2 Protection of individual workers. The safety precautions to be taken to protect workers are dealt with in Chapter 3.

4.2.3 Protection of the environment

- a) Very careful watch should be kept on the storage and daily use of insecticide. Poachers and others may attempt to steal insecticide for putting into ponds and rivers to catch fish.
- b) Bathing and washing of clothing worn during insecticidal operations must not be done directly in a stream or pool, otherwise this water will become seriously contaminated (unhealthy). This could harm villagers living downstream, and fish will

be destroyed. Instead, washing should be done in water brought to the camp for the purpose.

- c) Contaminated water left over after washing, rinsing of containers, vehicles, etc., should be put into a washing pit. This is a pit measuring about 5 m. x 3 m., and 2 m deep.

Finding if a good spot for the washing pit is a very important part of selecting a camp area:

- the soil should be deep enough (before rock is reached)
- the place chosen for the pit should be far away from the stream or the well from which camp water is taken
- the place chosen should not be near gardens or crops.

When the camp is moved, the washing pit must be filled to the top with earth.

- d) It is recommended that empty metal insecticide containers be disposed of by knocking a hole in the top and bottom, and flattening before burial in a pit. This makes sure that the containers will not be used for household or other purposes. Bags and cartons which contained insecticide must be buried or burned.

4.3 EQUIPMENT, REPAIR AND MAINTENANCE

The following types of spraying machinery are briefly described here:

- a) Pressurized knapsack sprayers
- b) Motorised mist-blowers.

Tractor borne sprayers are described under 4.9.

4.3.1 Pressure-retaining knapsack sprayers. These sprayers are carried on the back, with the help of shoulder straps. They consist of a cylindrical tank containing insecticide spray liquid. The liquid is pressurised using a hand pump.

If filled and pressurized correctly, all the spray liquid (charge) can be sprayed from the nozzle without repumping.

The advantage of pressurised sprayers over older knapsack sprayer designs is that continuous pumping in the field is not necessary. This frees one hand for helping the operator to move about in the bush. It also makes the work less difficult.

4.3.1.1 Parts

- a) Cylinder (reservoir or tank), made of stainless steel, copper or heavy duty plastic.
- b) Pump and pressure system. The pump is usually centrally placed, sometimes at the side. It consists of:

- Pump handle
- Piston
- Pump cylinder
- Safety valve.

There is also a pressure gauge fixed to the cylinder.

- c) Refill system. According to the model, there are two types:
- 1st type has a funnel of moulded plastic attached to the top opening, or a removeable lid.
 - 2nd type has an intake point at the base, with pipe and valve.
- d) Spray system.
- Rubber or plastic hose
 - Lance handle/valve
 - Trigger
 - Lance
 - Nozzle
 - Pressure control valve.
- e) Harness:
- Straps and their points of attachment
 - Back plate.

4.3.1.2 Maintenance and spare parts. Maintenance should be according to manufacturers instructions. Spare part kits are generally available from manufacturers.

The parts most often needing replacement will be:

- Nozzles
- Lances and trigger valves
- Rubber/plastic hose
- Washers.

Nozzle aperture must be carefully inspected with the use of a gauge, to ensure that it is of the correct size. It can become blocked, and so give insufficient flow, or become eroded and producing too fast a flow of spray mixture.

When in use, the sprayers should operate at the correct delivery pressure (according to the model of sprayer used, and the policy of the spray unit), and checks will have to be made from time to time.

4.3.1.3 Getting the sprayer ready for use

a) Pressurised knapsack sprayers refilling at the top.

- i) Unscrew the pump of the tank (after making sure there is no pressure inside the tank).
- ii) Pour spray liquid through the funnel into the tank. Do not add more than the recommended amount.

- iii) Replace the pump in the tank. Screw on tightly.
 - iv) Pump until the needle of the pressure gauge reaches the red mark.
 - v) Fix the pump handle into the locked position.
 - vi) Lift the sprayer on to the back of the spray operator.
 - vii) Test the sprayer by using the trigger, aiming the lance at a tree trunk.
- b) Pressurised knapsack sprayers refilling from the base by pumping.
- i) Place the intake filter in the spray liquid and work the pump 15 to 20 times.
 - ii) Lift out the intake filter and pump in air until the needle on the pressure gauge reaches the first mark (about 100 strokes of the pump are needed).
 - iii) Place the intake filter into the spray liquid again, and work the pump until the needle reaches the red mark.
 - iv) Lift the sprayer on to the back of the spray operator.
 - v) Test the sprayer by using the trigger, aiming the lance at a tree trunk.

This type of sprayer has to be pressurized only at the start of each day's work. It retains some pressure until the next refill, when it is automatically brought to full pressure as the spray liquid is pumped in.

4.3.1.4 Cleaning. At the end of the day's work all sprayers must be carefully rinsed and wiped. Insecticide left inside damages pipes and valves.

- i) Allow excess insecticide and pressure to escape through the nozzle (if necessary, the nozzles can be removed to make the job quicker).
- ii) Partly fill the sprayer with clean water, shake, and empty again. Never empty or clean the sprayer in or near streams or ponds.
- iii) Refill a second time, close the apparatus, pressurise, and spray water through the lance until empty. The nozzle can be unscrewed for a while to make the job quicker.
- iv) Place sprayers in position ready for the next day's work.

4.3.2 Motor mist-blowers. These sprayers are also carried on the back, with the help of shoulder straps.

The spray liquid passes from a plastic tank of about 10 litres capacity through a flexible pipe to a nozzle.

A 2-stroke motor (50 cc) drives a fan. This sends compressed air through a wide hose to the nozzle. The action of the compressed air breaks up the insecticide liquid into a spray which is forced out of the nozzle.

The fan also drives some compressed air into the tank, so forcing spray liquid along towards the nozzle.

4.3.2.1 Parts

a) 2-stroke motor:

- Crankcase, cylinder with piston, exhaust/muffler
- Fuel tank (oil-petrol mixture), fuel line
- Carburettor, throttle cable, throttle control level
- Magneto, spark plug, condenser
- Starter grip, rope rotor.

b) Air blow system:

- Fan wheel and casing
- Wide flexible hose
- Handle, tube and nozzle

c) Spray liquid supply system:

- Tank
- Hose (about 12 mm. diameter) from tank to nozzle
- Level controlling flow of insecticide.

d) Harness:

- Straps and their points of attachment
- Plastic back plate.

4.3.2.2 Maintenance and spare parts. Maintenance should be according to manufacturers' instructions. Repairs should be made by a trained mechanic. Casual repair will cause greater problems.

Motor service kits may be obtained from manufacturers. Plenty of spare parts should be ordered at the same time as ordering the sprayers.

Sparking plugs should be cleared every day.

Condensers and sparking plugs will have to be replaced as recommended by the manufacturers.

Plastic tanks may suffer from the combined effects of strong sunlight and insecticide, and have to be replaced.

4.3.2.3 Getting the motor mist-blower ready for use

- i) Pour spray liquid into the tank, replace filler cap, check that all joints in the spray liquid supply line are water-tight.
- ii) Put fuel into fuel tank (25:1 petrol/oil mixture, after a running-in period)
- iii) Adjust action of choke to overflow point in carburettor
- iv) Switch fuel control to half way
- v) Start the motor by pulling the starting cable gently until there is a slight resistance, then pull sharply.
- vi) The motor should be allowed to warm up for a few minutes.
- vii) Open the spray liquid tap and adjust the force and the tip of jet as required.

4.3.3 Additional equipment. Besides the spraying equipment, some other equipment is required for:

- a) Pumping and transport of water to be used for mixing, washing, etc.
- b) Mixing
- c) Spray lane clearing
- d) Access road making.

4.3.3.1 Water pumps. With these water can be pumped from rivers, streams and pools to storage tanks and drums.

For water pumps to operate well under field conditions, they must be of:

- a movable type (not fixed to a lorry chassis)
- medium weight (70-80 kg. maximum)
- fairly strong pumping power, able to pump at least 5 m. above the level of the water being pumped
- robust, simple design, with relatively slow r.p.m. (less than 3 600)
- a type running on the same fuel as the carrier vehicle
- sufficient delivery rate (at least 4 cubic metres/hour)
- a type able to deal with the water found under field conditions.

Use of water pumps (see Figure 4.1)

- a) Lorry carrying water tank or drums is brought as close as possible to the water.
- b) Pump is placed on bank.
- c) Suction hose (of semi-rigid, non-collapsible type) of about 10 m. is placed so that the lower free end carrying a suction filter is under water, but held clear of mud and slime. A Y-shaped branch can be used to support this end of the pipe, or a closed plastic container tied to the pipe near to the end.

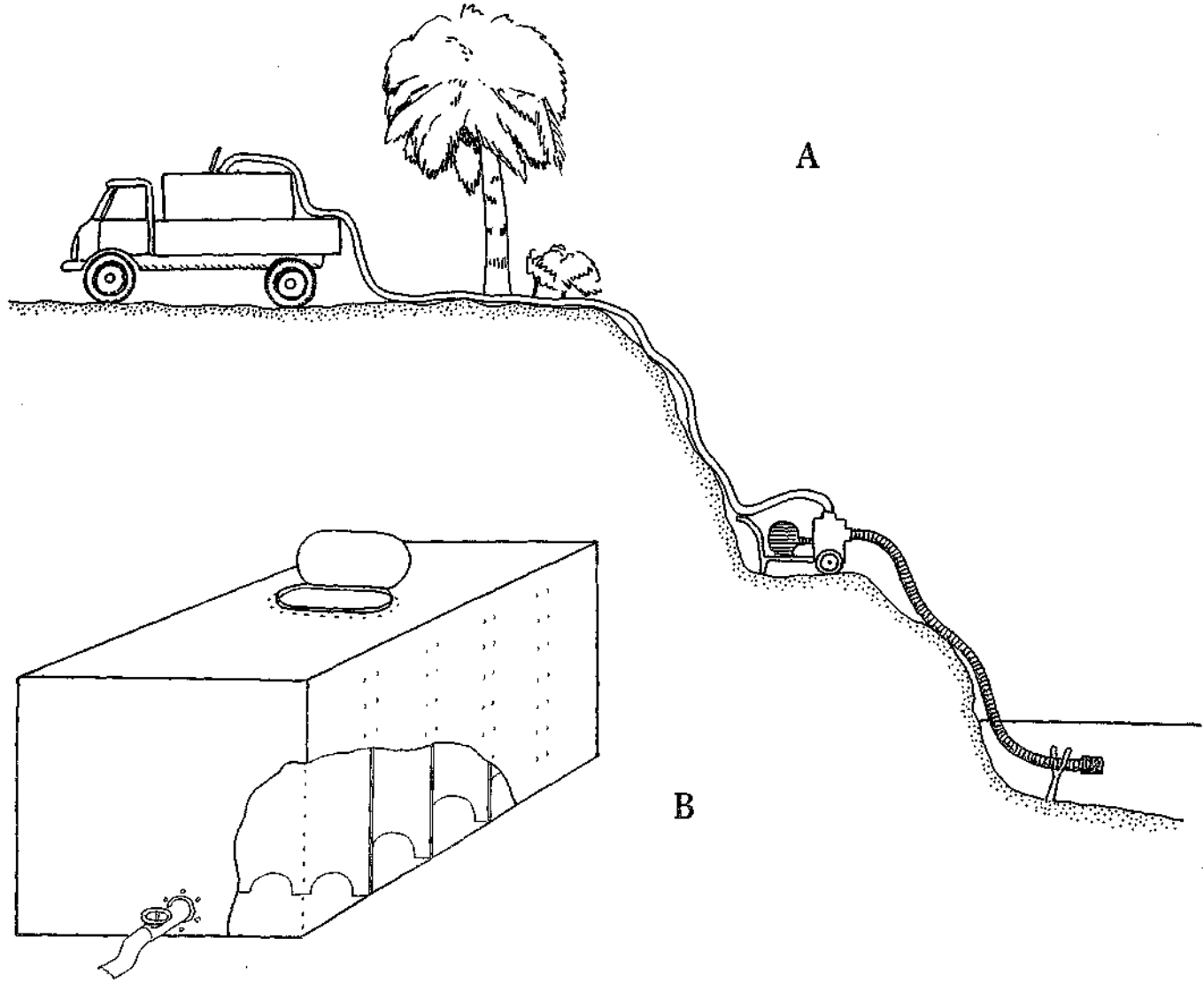

Figure 4.1 A. Method of using a water pump to raise water up a steep bank.
B. Exploded view of water tank.

- d) Discharge from the pump is through 30-40 m. long flexible canvas hose (two sections of 20 m. each is the best arrangement).
- e) After use, rinse out with clean water. Roll up the hose carefully.
- f) The pump should run only when the foot valve is under water.

4.3.3.2 Mixing equipment. The team requires:

- a) Two rubberised buckets or metal containers with which to measure out insecticide.
- b) Two 200 l. drums with one end removed for mixing.
- c) Two 1/2 drums of 100 l. each.
- d) One or more stirring sticks with which to mix the spray mixture.
- e) Protective clothing, goggles, rubber gloves, masks, boots.

4.3.3.3 Bush cutting equipment

- a) Machets (pangas)
- b) Hand axes.

One worker will have the job of sharpening these tools every afternoon. The handles should be inspected to make sure they are firmly fixed to the axe head or panga blade.

The subject of vehicles, their repair and maintenance, is not covered in this Manual.

4.4 SPRAYING PROGRAMMES (WEST AFRICA)

This section deals with:

- a) How to apply a spray to vegetation
- b) which types of vegetation should be sprayed
- c) which parts of the trees, shrubs, etc. should be sprayed

with particular reference to West African conditions, although much of it is applicable elsewhere.

4.4.1 Spraying technique

- a) The nozzle type of a pressurised knapsack sprayer will give a jet of droplets of a size greater than 100 μm .
- b) The nozzle must be held at the correct distance from the vegetation (Figure 4.2);
 - if it is too far away, then much of the spray misses the target,
 - if it is too near, then too much insecticide is put on one place and there is run-off.
- c) If a motor mist-blower is used, then the rate of blowing should be correctly adjusted;
 - too low a rate causes insecticide to fail to reach the target,

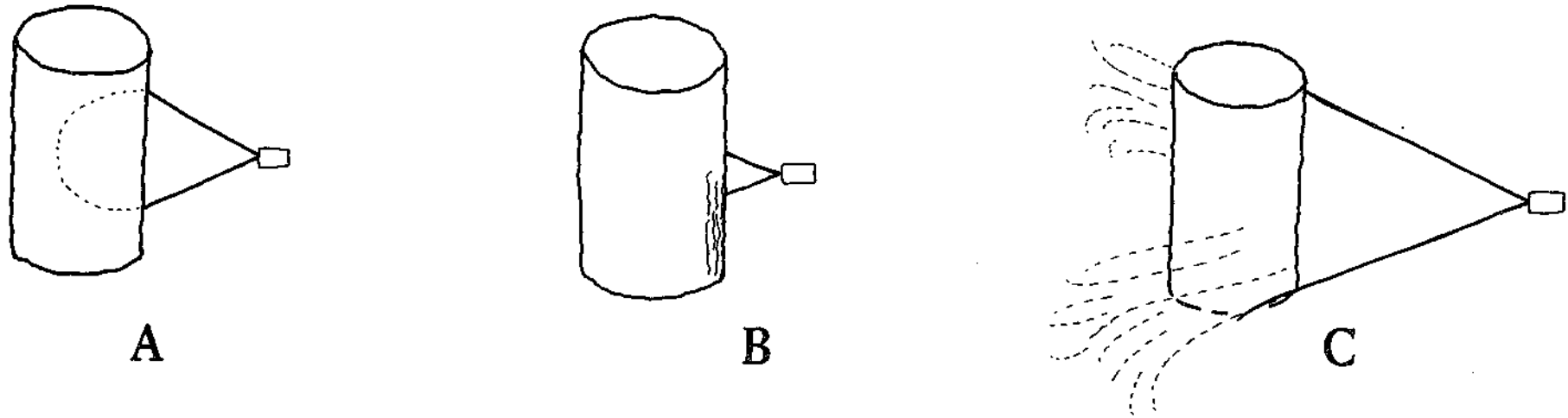

Figure 4.2 Position of nozzle when spraying. A. Nozzle the correct distance away from the vegetation being sprayed. B. Nozzle too close to the vegetation, resulting in run-off. C. Nozzle too far away from the vegetation, resulting in insecticide missing the target.

(Adapted from Howell Davies, "Tsetse Flies in Nigeria" 1977, 3rd Ed.)

too high a rate and the deposit of insecticide formed is not enough.

At the start of a spraying campaign, the spray operators should be carefully supervised and trained, so that they quickly learn how to spray insecticides correctly, putting it on neither too thickly nor too thinly.

A tree-trunk correctly treated with insecticide suspension has an even, whitish-grey deposit. However, some trees show this more clearly than others.

4.4.1.2 Vegetation types to be sprayed (discriminative spraying) Normally, some types of vegetation and not all, are chosen for treatment. This is called discriminative spraying.

Depending on the overall vegetation, as little as 10% of the total area may have to be treated.

Discriminative spraying therefore reduces costs and contamination of the environment, while still eradicating the tsetse.

However, the spraying that is done has to be applied to exactly the right places, which depends on the zone and the tsetse species concerned (see 4.4.6, 4.4.7, and 4.4.8).

4.4.1.3 Parts of the trees and shrubs to be sprayed (selective spraying) In general, selective spraying attempts to place insecticide only on the parts of trees, bushes, etc., used by tsetse as resting places, and this depends on tsetse species and local conditions.

Information on resting sites for different species is given in Volume II, and spraying instructions are given in 4.4.6 of this chapter.

In the case of thickets, spraying cannot be so selective. The lance of the sprayer is thrust into the thicket and the trigger depressed for a few moments. This is repeated at intervals around the thicket. The motor mist-blower is well suited for this type of vegetation.

The following gives examples of the types of instructions that might be given to spray operators:

- "Spray to the height of your shoulders"
- "Spray to waist height"
- "If you find isolates trees, spray them only if their trunks are thicker than the arm. Smaller trees are treated only if they are arranged in clumps like a bush"
- "Spray the trunks and the lower faces of branches from the base to the top and from the top to the base alternately in a continuous movement, and do not spray the same spot twice".

4.4.1.4 Bush clearing to assist spraying Some bush clearing is necessary before spraying:

- to cut an access route for vehicles as far as the refill points
- to prepare paths for spray operators through the vegetation of the habitat, for instance through a thicket
- to clear away fringing vegetation from around trunks and branches that have to be sprayed.

Instructions that might be given to bush clearing workers:

- "It is necessary that the spray operators should be able to walk easily through the vegetation with the heavy equipment they carry on their backs"
- "Imagine that you are making a path for a woman with a baby on her back; the branches must not scratch the baby"
- "Bush clearing does not mean that everything should be cut".

- "The spray operators must walk through and spray the insecticide on the tree trunks and under branches; all undergrowth that stands in the way must be removed"
- "Prepare a track for the lorries using machets (pangas) for undergrowth and axes for small trees. Stumps must be removed. Mark out the route well by slashing the bark on both sides of the track. The track must be easily followed from both directions".

4.4.1.5 Chemical barriers; blanket or non-selective spraying. At the end of each spraying season, the area cleared of tsetse has to be protected from re-invasion. This protection is provided by chemical barriers: these are zones between the cleared area and tsetse-infested areas nearby, which are sprayed heavily with insecticide.

- a) A double strength insecticide mixture may be used (for example D.D.T. 5% a.i., or dieldrin 4% a.i. in the Sudan zone).
- b) Spraying is ruthless, not selective or discriminative. All the vegetation in the barrier zone is sprayed.
- c) Against reinvasion by riverine tsetse, chemical barriers are usually laid down across the banks of water courses leading to or from a cleared area:
 - the length and width of the chemical barrier depends on the size of the river, and its vegetation
 - the chemical barrier must be renewed each year for as long as the eradication programme does not pass beyond that point.
- d) Against re-invasion by savanna tsetse:
 - on all the edge of the cleared zone in contact with zones remaining infested

- often placed along the length of roads, cattle routes, water sheds, etc.; these barriers may have to be very long. For example, in Nigeria a chemical barrier 1.6 km. (1 mile) by 160 km. (100 miles) was laid down along the Biu-Gambi-Mubi road at the southern limit of the preceeding year's treatment.
- e) Time of spraying. If the spray programme is intended to progress further in the next dry season, then the chemical barrier is laid down at the end of the current dry season.
- If the spray programme is intended to stop for a year or more, then to hold back re-invading tsetse, the chemical barrier has to be resprayed once at the beginning of each dry season, and again at the end of the dry season. Deposits are washed off in the heavy rains.
- f) Possible reasons for failure of chemical barriers:
- poor selection of points of possible reinfestation
 - penetration by tsetses carried on vehicles. Pickets (see Volume I, 7.9) may be used to reduce this
 - by-passing of chemical barriers by wandering herds of cattle. The siting of chemical barriers should take account of traditional cattle routes (see Fig. 4.3).

4.4.1.6 Spraying against G. tachinoides

- a) In Sudan zone:
- 2 1/2% of D.D.T. w.p. sprayed from knapsack sprayers

- discriminative spraying of banks of streams and drainage lines to a maximum distance of about 4.5 m. (5 yards) from the water
 - selective spraying of tree trunks and other woody vegetation from ground level to a height of 1 m. (3 ft.) (see Fig. 4.4B)
- b) In Northern Guinea zone, as in (a), but use
- 3 1/2% D.D.T. w.p. sprayed from knapsack sprayers
 - discriminative spraying of banks to a maximum distance of 8 m. (9 yards) from the water.
- c) In southern Guinea zone, as in (b) but use
- 2% dieldrin e.c.
 - discriminative spraying of banks to a maximum distance of 10 m. (11 yards)
 - selective spraying of all woody vegetation from ground level to a height of 2 m. (6 feet).

4.4.1.7 Spraying against G. palpalis

- a) In Sudan zone
- 2 1/2% D.D.T. w.p. sprayed from knapsack sprayers
 - discriminative spraying of banks of streams and drainage lines to a maximum distance of 4.5 m. (5 yards) from the water
 - selective spraying of tree trunks and other woody vegetation from ground level to a height of 1.5 m. (5 feet).

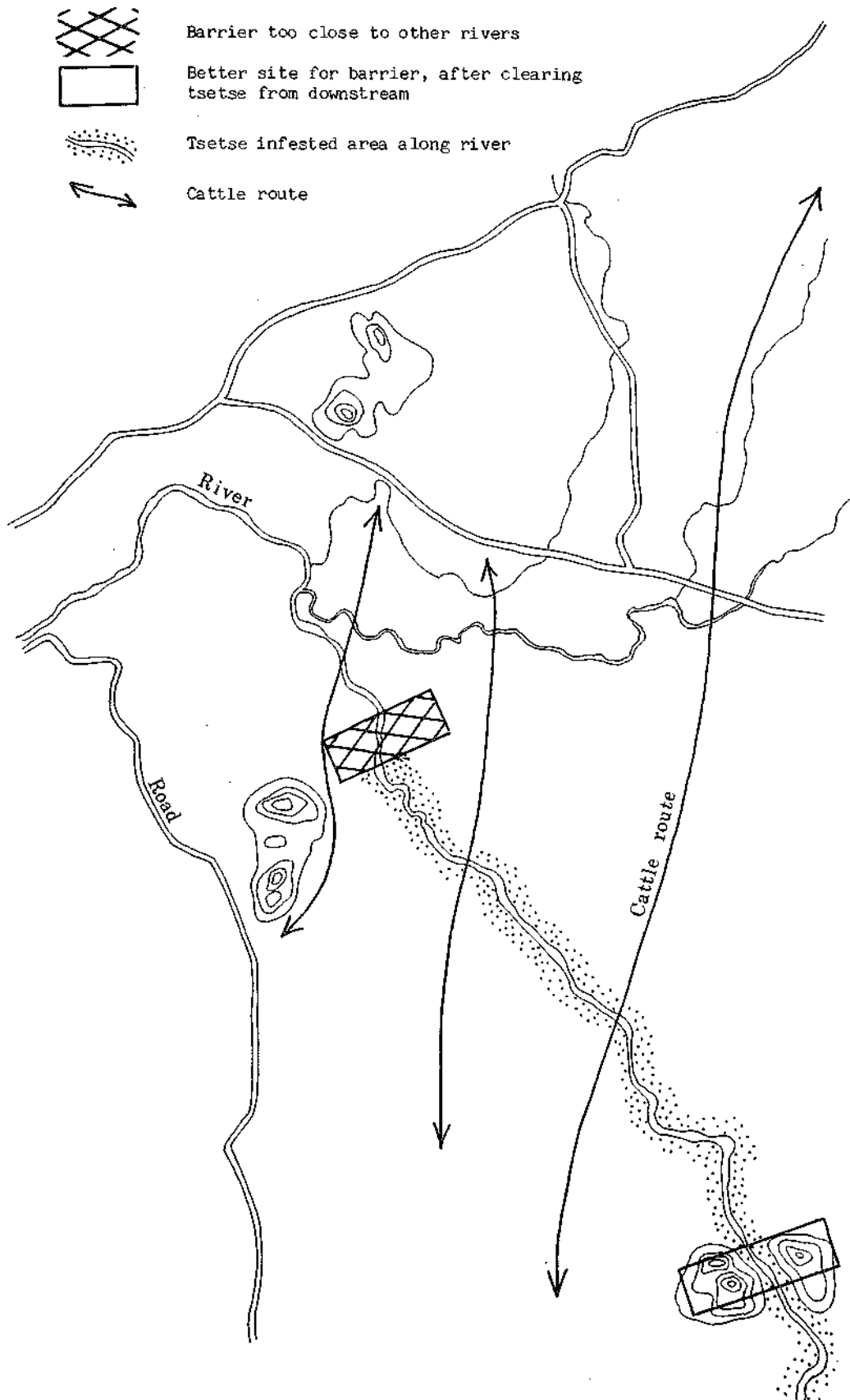

Figure 4.3 Map to illustrate the problem of siting a chemical barrier

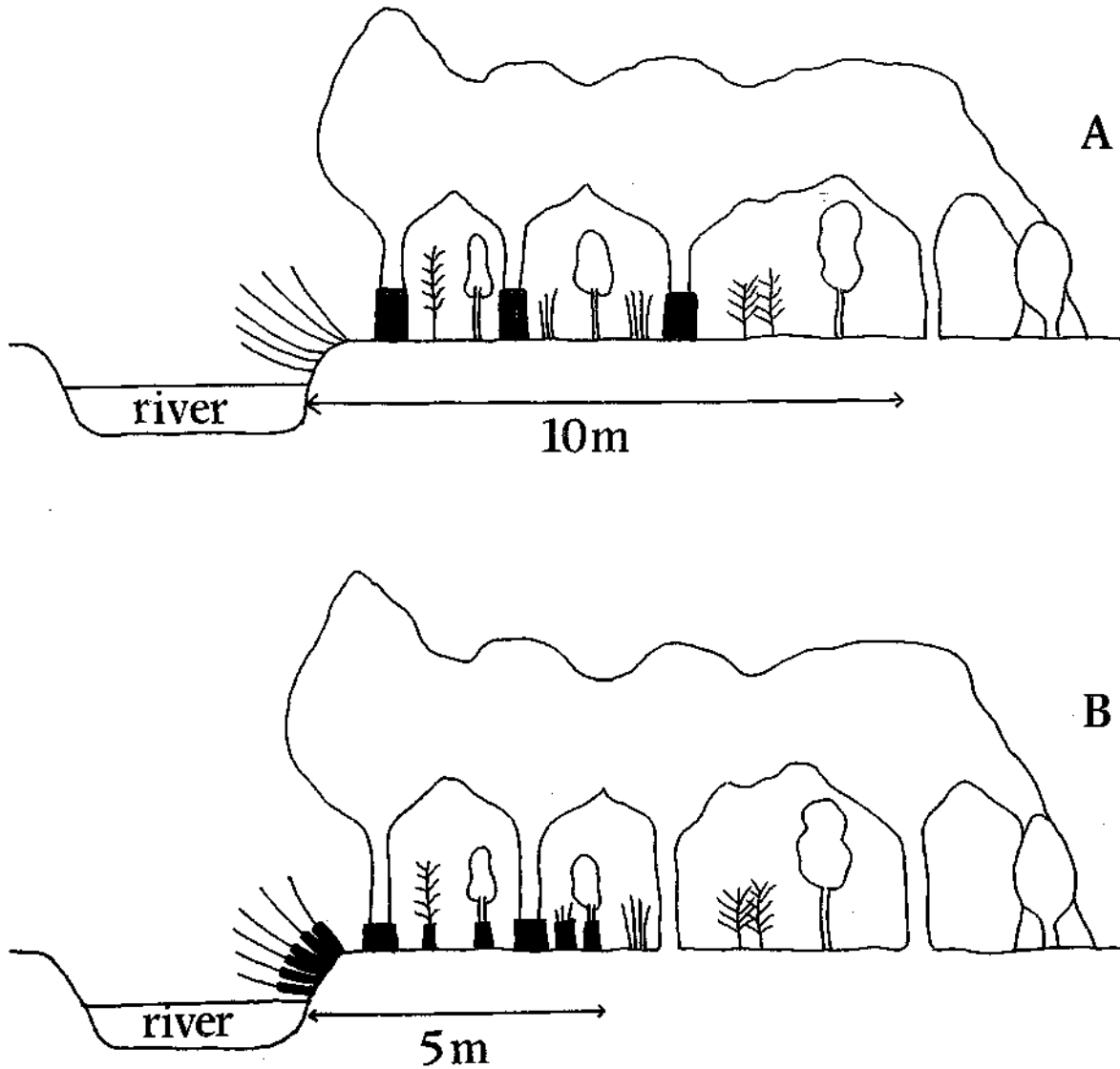

Figure 4.4 Profiles of fringing forest, Sudan vegetation zone, to show sites (black) which are sprayed by knapsack sprayers.

- A. Sites to be sprayed in selective spraying campaigns against *Glossina morsitans*.
- B. Sites to be sprayed in selective spraying campaigns against *G. tachinoides*.

(Adapted from Howell Davies, "Tsetse Flies in Nigeria", 1977, 3rd edition).

- b) In northern Guinea zone and southern Guinea zone, as in (a) but use
- 2% dieldrin from motor mist-blowers
 - discriminative spraying as in (a)
 - selective spraying of all woody vegetation from ground level to a height of 2 m. (6 feet).

4.4.1.8 Spraying against *G. morsitans* in West Africa.

- a) In Sudan zone
- 2 1/2% D.D.T. w.p. sprayed from knapsack sprayers
 - discriminative spraying of riverine vegetation, 10 m. (11 yards) strip on both banks; or if the gallery forest is wide, then this forest is sprayed along cross-strips 20 m. (22 yards) wide, placed 100 m. (120 yards) apart.
 - selective spraying of tree trunks more than 25 cm. (10 inches) thick, from ground level to 1 m. (3 feet) in northern areas, and 2 m. (6 feet) in southern areas (see Figure 4.4A).
- b) In northern Guinea savanna zone, as in (a) but use
- 3 1/2% D.D.T. w.p. sprayed from knapsack sprayers
 - discriminative spraying of riverine vegetation and *Isoberlinia doka* woodland. A strip 80 m. (90 yards) wide is sprayed around each woodland area. If the wooded areas are large, then strips 80 m. (90 yards) wide are sprayed across the woodland from one side to the other, the

strips being placed 100 m. (110 yards) apart. Along the transition zone (ecotone) between thick riverine vegetation and thinner savanna woodland, an 80 m. (90 yards) strip is sprayed. In the belt of thicker vegetation around the base of hills one 80 m. (90 yards) strip is sprayed all round; if the vegetation is wide then two of these strips are sprayed, one along the inner margin of the woodland, one along the outer margin. The woody vegetation at the sides of roads, tracks and paths is sprayed to a depth of 80 m. (90 yards).

4.4.2 Organisation of a spraying programme

4.4.2.1 Personnel and equipment A field tsetse control unit consists of a number of spray teams. The following is an example of the composition of a spray team.

Team Leader			
<u>Bush clearing</u> section	<u>Knapsack spraying</u> section	<u>Motor mist-blower</u> section	<u>Refilling</u> section
1 Foreman 20 workers	1 foreman 12 workers	1 foreman 6 workers	4 workers 1 water pump
20 machets (pangas) 5 axes 2 sharpening stones and files	30 pressurized knapsack sprayers Spare parts	4 mist-blowers 4 watering cans	3 drums 200 l. 2 1/2 drums 100 l. 3 buckets 20 l.

The numbers of personnel may be varied to suit special circumstances. Small teams are better in that they are easier to lodge in villages.

In practice, knapsack sprayers and motor mist-blowers may be used in separate exercises, depending on circumstances.

If possible, unskilled labour should be recruited from local villages.

4.4.2.2 Types of vehicles The number of lorries required is double that used by the survey group that has already covered the area (assuming that the number of teams is the same).

The extra lorries are equipped with a water tank (1500-2000 l.) or they carry drums. Also, 3.5 tonne (or larger) lorries (four-wheel drive) will be required to transport heavy equipment (one lorry per two teams).

4.4.2.3 Spraying equipment The number of knapsack sprayers to stock should be well in excess of the number of spray operators. The stock of spare parts should amount to 20% of the value of the sprayers.

This equipment should be stored and maintained in a store/workshop.

Water pumps: either

- large model: 1 water pump/team
- small model: 1 water pump/team, plus 1 or 2 water pumps in reserve.

4.4.2.4 Insecticides The ordering of insecticide is the responsibility of headquarters. Account should be taken of the long delays in delivery that may occur, especially in land-locked countries (6 months or more).

The estimate of the amount required will depend on the survey findings (area to be treated, length of water courses/drainage lines) (see 4.8).

The insecticide should be of the required standard (amount of active ingredient; ability to make a satisfactory suspension or emulsion; ability to withstand tropical storage).

The condition of containers is equally important, whether of drums or sacks, especially where delivery distances are very long. It is an advantage to order insecticide to be delivered in containers of a size that suits mixing requirements, unless much extra cost is involved in doing so.

4.4.2.5 Timetable of operations throughout the year

- a) Preparing the spray programme
 - i) Recruitment of personnel
 - ii) Construction work: field office, workshop, sleeping quarters
 - iii) Buying of equipment (sprayers, vehicles, etc.)
 - iv) Planning

In general this preparatory work goes on at the same time as the survey operations.

- b) Spraying
 - i) Set up field organisation
 - ii) Carry out the spray programme in the dry season
 - iii) Receive reports and accounts from team leaders
- c) Close down of operation.

4.4.2.6 Example of timetable of operations during a working day (taken from West African experience)

- i) Departure for the refill site

- Half an hour before sunrise: call the workers together to get on board the transport lorry. Travel to the refill site.

ii) Arrival at the refill site

- Fill up the sprayer tanks from a drum of spray liquid that has been prepared the day before (stir well before pouring).
- Spray operators set out on the first wave of spraying.
- Fill the other knapsack sprayers.
- Prepare a new drum of spray liquid (the water tank or drums of the supply lorry for the refill site having been filled with water the day before).

iii) Daily routine

- The spray operators having emptied their sprayers, return to pick up another full sprayer, and hand over the old one for refilling.
- Labourers may instead do the work of carrying the refilled sprayers to the operators in the field, and of returning the emptied sprayers.
- The motor mist-blower is operated by a skilled man, who is kept supplied with spray liquid by an assistant from the refill site.

iv) Moving the refill site

- At regular intervals, the team leader or foreman moves the refill site so that it is closer to the point at which spraying is being carried out. This is done once or twice (at the most) during the day's work, either at about the end of the first third of the day's work

(8.30-9.00), or about one hour before stopping the spraying (11.00-11.30).

The new site will be placed so that it anticipates the next day's progress. Spray operators are kept informed of this new site.

The distance between the new site and the old depends on the type of habitat being sprayed.

- A long straight habitat, such as river: large distances (say 1-2 km).
- Wide extensive habitat, such as miombo woodland: short distances (say 500 m.).

v) Water lorry shuttle service.

- For a team of 50 persons (servicing 15-18 spray operators) one journey per day to the water pump and back is enough, since the total of spray liquid used in one day does not exceed 1000 l.

- At the close of work for the day, the quantity of water available should be:

For rinsing out machines	200 l.
--------------------------	--------

For preparing spray liquid for next day	200 l.
---	--------

For preparing a second drum of spray liquid after refilling the first wave of sprayers	200 l.
--	--------

Total	600 l.
-------	--------

- If it looks as if the water available will not be enough, the lorry must be refilled in good time. No wastage of time can be permitted in a spraying programme.

vi) Closing the day's spraying work.

- At 12.30 the refill section stops supplying refilled sprayers. All emptied sprayers are carefully washed and cleaned.
- The sprayers are set out empty and clean, ready for the next day.
- Faulty machines are repaired.
- A drum of spray mixture may be prepared in advance for the next day.
- Workers are transported back to base.

vii) Work of the bush clearing section

- The bush clearing gang must be one day's work ahead of the sprayers.
- One part of the team (5 labourers) is responsible for marking out the roads to be used by the lorries. The route will normally lie alongside the vegetation to be sprayed (e.g. gallery forest) in order to reduce the walking necessary between refill point and the spraying point.

viii) Work of the team leader.

- The team leader makes frequent visits between the various work areas: spraying point, bush clearing area, refill site. He is moving about all the time.
- He must make sure the work is being carried out correctly: Control of lane cutting, control of insecticide spraying, control of foreman.
- Correct management of a spraying team requires authority from the team leader. Lax discipline will lead to a poor operation.

Note: According to local circumstances, climatic conditions, etc., these time-tables may have to be adjusted.

4.4.3 Strategy

- 4.4.3.1 Chances of successful eradication of riverine and savannah tsetse does not give great problems, so long as careful surveys have been made.

Eradication of savanna tsetse is more difficult because the favoured habitats are more widely scattered. It is necessary to be extremely careful when carrying out surveys as pockets of fly may easily be missed. The areas which are to be sprayed will depend directly on the survey results.

- 4.4.3.2 Conduct of spraying campaign against riverine tsetse (Figure 4.5) Avoid moving from a favoured habitat to a less favoured (marginal) habitat when spraying, as this may cause tsetse to move away into areas where they can survive, and avoid contact with insecticide deposits.

The spraying teams must work in pairs, and as follows:

- a) the two banks of a river are treated at the same time
- b) teams move towards each other on the same river banks
- c) where it is necessary to spray the whole of a gallery forest, spraying takes place on the outside of the forest, before working inwards
- d) along small streams at the outer limits of tsetse infestation, down towards the main river

Possible mistakes in conduct of work:

- a) using a single team to work an area may result in one stream bank being treated so long after the opposite one, that flies may reinfest the first bank treated before the second one is dealt with.

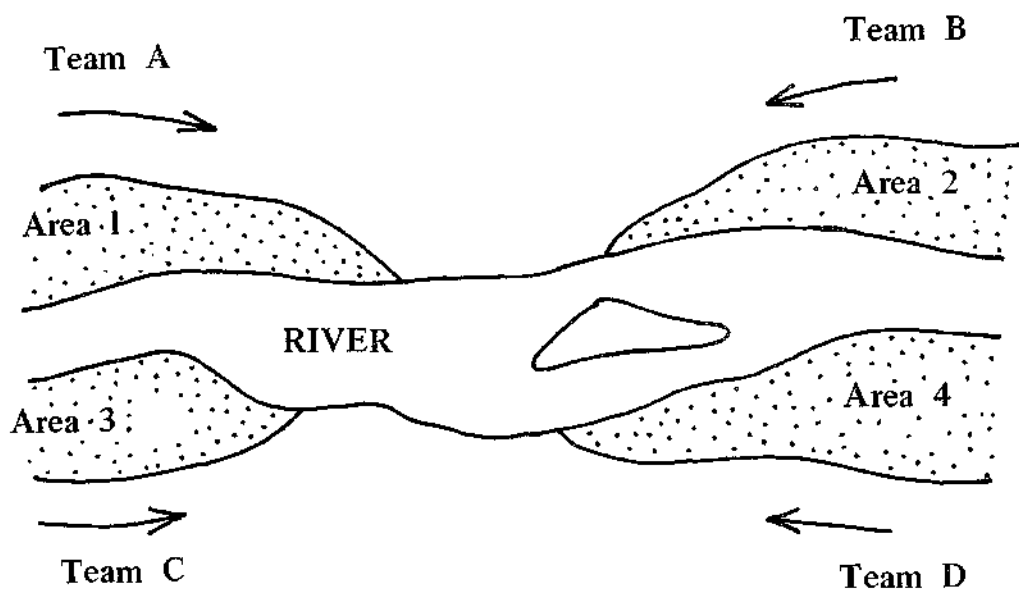

Figure 4.5 Co-ordinated action of four teams spraying tsetse-infested river vegetation.

- b) at the approach of the rainy season, there is a risk of pushing tsetse towards vegetation types which can act as temporary homes until the onset of the rains. Hence the need to spray from the less favourable habitats inwards towards the more favoured habitats.

4.4.3.3 Conduct of spraying campaign against savanna tsetse Basic principles:

- a) The tsetse of the savanna are very dispersed in the rainy season and during the first months of the dry season.
- b) In the hot dry season of Northern Guinea savanna, they are limited to more restricted habitats:
- (in West Africa) living together with riverine tsetse in gallery forest and stream vegetation
 - in the wider habitat:
 - along drainage lines
 - at head waters of streams
 - at edge of flood plains
 - at border of hills, escarpments, etc.

The widely distributed nature of these habitats makes it difficult to know where to draw the limits of a spray campaign, and how to prevent reinfestation over a broad front. Use of aerial photographs is of the greatest assistance here. Possible mistakes in the conduct of work:

- a) Not having enough teams in the field required for spraying the very large areas to be cleared.
- b) Failing to spray certain areas that are difficult to get at, or were overlooked during survey. The helicopter method (Chapter 6) can in certain cases correct these local failures.

- c) Having insufficient chemical barriers; chemical barriers have to be much larger than is the case for riverine tsetse.

4.4.3.4 Conduct of spraying campaign against forest tsetse (fusca group) Spraying against fusca group tsetse is done only in so far as their distribution overlaps those of riverine and savanna tsetse.

There are no known methods for eradicating tsetse from forested or semi-forested areas. Only control methods on a small scale can be used.

4.4.4. Reporting

Each day of spraying, the team leader writes up a spraying report. The following information is required:

Name of the team leader

Date

Village name at which the team is lodging/
camping

Time of start of spraying

Time of end of spraying

Place of spraying

Length of gallery forest treated (if applicable)

Estimated area

Quantity of insecticide used (number of knap-
sacks sprayed)

Volume of spray liquid made

Number of refill points

Number of knapsack sprayers in good order/
out of order

Record of distance travelled by all vehicles.

Also a map traced from the earlier survey,
showing:

The point at which spraying started for the
day

The direction in which spraying progressed
(shown by arrows), and ground covered (shown
by coloured line)

The points at which refill sites were placed

The point at which spraying finished for the
day

Other points of interest, such as where the
spraying method was altered for any reason.

4.4.5 Estimates used in planning spraying programme

These estimates are based mainly on West African
conditions.

a) Consumption of insecticide/ha or/linear km.

		<u>D.D.T.</u> a.i.	<u>Dieldrin</u> a.i.
Per hectare of habitat, of vegetation density:	medium	3 kg.	2 kg.
	thick	6 kg.	4 kg.
	very thick	9 kg.	6 kg.
Per kilometer of treated river:	linear vegetation	10 kg.	7 kg.
	medium gallery forest	50 kg.	35 kg.
	large gallery forest	100 kg.	70 kg.

b) Rate of treating an area, ha/day.

One team of medium strength (42 workers, using 12 knapsack sprayers and 3 motor mist-blowers) will be able to cover the following per day:

Habitat of vegetation density:	medium	14 ha
	thick	10 ha
	very thick	7 ha
River length	Linear vegetation (width 30 m.)	4 km
	Medium gallery forest (width 100 m.)	1.4 km
	Large gallery forest (width 200 m.)	0.7 km

c) Rate of treating an area, km²/month.

In West Africa one team of medium strength can cover:

<u>Climatic zone</u>	<u>River Drainage System</u>	<u>km²</u>
Sahel-Sudan	Poor	300
Sudan	Medium	150
Sudan-Guinea	Dense	100
Guinea	Very Dense	50

d) Amount of insecticide used by a team of medium strength per day or per month (assuming a team of this size sprays about 1600 l. per day):

<u>Mixture</u> (period)	<u>D.D.T. 2.5%</u>	<u>Dieldrin 2%</u>
per day	40 kg.	32 kg.
per month	1200 kg.	960 kg.

4.5 SPRAYING PROGRAMMES (SOUTHERN/CENTRAL AFRICA)

4.5.1 Preliminaries to spraying

4.5.1.1 Planning. It is recommended that as much as possible of the spraying routines is planned at Headquarters, well before spraying commences.

- (a) Ideally, a biologist at Headquarters will have available an up-to-date set of aerial photographs of the area to be sprayed. He will also have a stereoscope with which to view stereopairs of these photographs. He will therefore be able to see where the heavier vegetation is. This vegetation will lie especially:

- along drainage lines and gulleys
- at the base of hills and escarpments.

According to the zone, these may be fairly extensive areas of uniform woodland.

- (b) The biologist marks out with a coloured felt tip pen (e.g. green) on the aerial photographs, lines representing the spray lines that will be followed on the ground. These coloured lines will be drawn on:

- vegetation along drainage lines. If the vegetation is not very thick a single line will be sufficient; if the vegetation is thick, for instance along the sides of a large stream, a double line can be drawn to indicate that two passes by the spray team will be required to deal with this tsetse habitat.
- woodland at the base of hills
- around thickets

- well-wooded roads and tracks
 - cattle tracks
 - woodland/dambo margin
 - along other ecotones, e.g. contact lines between woodland types
 - uniform woodland. In extensive areas of uniform savanna woodland that is not too dense, parallel lines are drawn on aerial photographs to represent swaths to be laid down by the spray teams. These swaths should normally be placed so as to be 200 - 300 m apart on the ground (grid spraying). This is appropriate treatment in semi-arid habitats. More humid forests may require that the parallel swaths should be arranged to cover the whole of forest habitat, not just a small percentage of it.
- (c) Routes to be taken by access roads now have to be marked out, using a different colour felt tip pen from that used for the spray lines (e.g. red). Existing roads and tracks are marked first. Then a network of other access roads are marked, bearing in mind:
- the requirement that spray lines should not be more than 3 km walk from the nearest access road
 - The gradient: for the convenience of the lorry drivers bringing teams and spray mixture to the spray sites, and to avoid gully erosion, access roads should as far as possible be planned along gently inclined gradients (which can be seen through the stereoscope). Animal tracks visible on the aerial photographs can often give a good guide for such routing in hilly areas.

- (d) Exact copies are made of these marked aerial photographs, and the originals put away safely in Headquarters. The copies will be used by the supervising field officers, and further copies will be made for team leaders, and those responsible for cutting the access roads.
- (e) The spray line and access road plans are also transferred to photocopy 1:50 000 maps and circulated to all field officers concerned with the ground spray programme.

4.5.1.2 Access roads

If funds allow it, the equipment available and the size of the spray operation sufficient, it may be possible to call upon bulldozers to make access roads for the teams to reach the spray sites. The procedure in Zimbabwe is to hire bulldozers to make access roads throughout the spray area, so that no point in the area is more than 3 km from a road.

A road-making team will work at least one month ahead of the expected date on which the spray teams are to move into a given area. An experienced field officer marks out, by reference to a duplicate set of aerial photographs in his possession, the route on the ground to be followed by the access road network. He has the discretion to alter the planned route in minor respects, if his inspection on the ground shows this to be necessary or advisable. For example, a newly cut road not registered on the aerial photographs may be available, or the plan may have envisaged a road to be cut through an area that has recently become a farm. His marking will take the form of painting trees (or rocks) so that the route is easily visible to the cutting team.

If bulldozers are to be used, they will follow the route marked out already. They will leave humps of earth at intervals, to reduce run off of rain and subsequent gully erosion.

If bulldozers are not available, a gang of men to cut roads can be used instead. They will remove trees including the stumps, taking particular care not to leave sharp stakes protruding from the ground which would otherwise cause punctures in the spray team lorries.

4.5.2 Personnel of the spray team

In Zimbabwe, a spray team consists of:

- 1 team leader (field assistant)
- 1 assistant team leader (sometimes he is a trainee)
- 8 knapsack sprayer operators (using four sprayers)
- 8 carriers
- 1 operator of the measuring wheel
- 1 lorry driver (sometimes with a helper)
- (1 cook/camp attendant, remaining at camp)

Generally, four teams camp together under a field officer's supervision.

The team leader and his assistant are permanent staff.

The knapsack sprayer operators and the carriers are casual labour recruited for the season. They may have to be given some elementary training, or they may be experienced men who have performed the work in previous campaigns.

The lorry drivers are specially hired. The other staff are also casual labour.

4.5.3 The daily routine

Work starts at first light, so personnel have to arise from sleep some time before this. The lorry carries the team, plus spray liquid, knapsack sprayers, insecticide containers and other minor equipment to a point on the access road as close as possible to the spray site.

On arrival, the spray liquid is stirred well, using a long pole reaching to the base of the container.

The knapsack sprayers are filled and pressurised, and all the 20 litre containers are filled with spray liquid.

The lorry driver records the number of each 20 litre container filled by him, the time of filling, and the name of the carrier. (This is done each time spray liquid is issued, throughout the day).

The lorry driver is instructed to move his position to points convenient for the carriers as the day's work proceeds and the spray site changes location.

The field assistant in charge of the spray team lines up his operators, each spaced at 15 m from the next, and moves the team through the woodland, spraying trees, fallen logs, etc. as they proceed.

The direction taken by the team is chosen by the team leader, after he has examined his marked aerial photographs. His job is to ensure that all marked areas are sprayed, and that no part is sprayed more than once. He has the discretion to direct the team to spray a zone that has not been marked on the aerial photographs, if in his view it would appear sensible to do so. Likewise, if (due to farm clearing, for instance) some woody vegetation has been removed or is thinner than shown on the aerial photographs, it may be omitted from the spraying treatment.

The operators will be directed to spray:

- trees with a diameter of more than 15 cm (6 ins) up to 3-4 m (as high as can be reached with the lance);
- horizontal (overhanging) branches of such trees;
- rot holes in trees;
- the underside of fallen logs;
- animal burrows;
- under overhanging rocks;
- along dried up river banks especially under large exposed tree roots;
- into thickets.

Operators will spray one side only of a smaller tree, but two sides of a very large tree. No surface will be sprayed more than once. A single motion is used to spray a tree bole from ground level to as high as can be reached. Spray should not be so dense as to result in run-off.

Spraying proceeds by operators working in pairs, one with a knapsack sprayer, and one without. One operator, not carrying a knapsack sprayer, goes ahead of his companion knapsack spray operator, to indicate the trees and other places to be sprayed, by tapping those points with a stick. Thus of the eight operators available in a team, four are using the knapsack sprayer, and four are leading their fellow workers.

When one sprayer has finished spraying its load of liquid, the operator informs the team leader who blows a whistle, at which all spraying stops. All

knapsack sprayers are carefully depressurised, opened, refilled from the carriers, closed and re-pressurised. The members of a pair then change functions, so that the one who was leading now does the spraying, and the one who was spraying does the leading. (This alteration in spraying proceeds throughout the working day).

During refilling, the team leader records the distance covered from the wheelman, the number of sprayers in use, and the volume of spray liquid used for the refill. The times of stopping and re-starting are also noted.

After refilling and re-pressurising the team leader blows his whistle, and spraying begins again.

Empty containers are taken back to the lorry for refilling, and returned to the spray site, by the carriers.

During progress in the field, the performance of two of the spray operations will be checked by the team leader, and the other two by the assistant team leader.

Through uniform woodland, along woodland/grass edges and along other ecotones, four operators will work side-by-side with about 15 m between each man, so as to cover a swath of some 60 m. width. For certain other work, it may be necessary to split the team so that two sprayers are in use in one area, and two in the other. Such situations might occur when spraying small gulleys, and other narrow drainage lines, around a small dambo (vlei) or along the sides of roads or broad cattle tracks.

On return to camp, the knapsack sprayers are disassembled and thoroughly washed. Washings go into the washing pit. Overalls are washed, and the team personnel take showers.

The team leader completes his records, and marks on the 1:50 000 map kept at the camp, the progress made during the day. The team leader will assist his supervisor in charge of the camp, in loading the lorry so as to be ready for the next day's work. A load will normally be of 750 l. spray liquid carried in six 100 litre containers or three 200 litre containers, together with the balance in 20 litre containers.

The team leader will ensure that he has the relevant aerial photographs, 1:50 000 maps (photocopies), record forms, pencil and stereoscope, ready for the next day's work. The photographs and maps will have to be studied in preparation for the next day's work. The mixing of the insecticide is under the camp supervisor's direction. For each team, two bags of 20 kg 75% DDT w.p. are mixed into 750 litres of water, giving 750 litres of 4% spray liquid.

4.5.4 The camp supervisor's functions

The field officer in charge of camp is in immediate authority over the team leaders. He supervises the issue of insecticide, the mixing of the spray liquid, the loading of the lorries, the safe disposal of wastes, the allocation of the areas to be sprayed the next day, the collation of data on the day's spraying, the marking of the map showing areas sprayed each day by each team, and the issue of spare parts. He communicates regularly with Headquarters or his own immediate superior as appropriate. In consultation with his superior officer, he shifts camp when the area around the currently occupied camp is sprayed. He ensures that camps are set up in a correct manner to avoid insecticidal contamination of water bodies.

He tours the area of operations of each team, to make sure that work is being carried out in the proper manner.

4.6 GROUND SPRAYING OF PERSISTENT INSECTICIDE FROM TRACTOR OPERATED PUMPS

In this method of ground spraying, persistent insecticide (D.D.T., dieldrin) is deposited on vegetation using power operated pumps mounted on Unimog vehicles.

The aims are as in knapsack spraying, to place a persistent insecticide on tsetse resting sites, by discriminative and selective spraying.

The method is at present used in parts of southern central Africa, and is used principally against G. morsitans in dry, deciduous woodland, escarpment and valley areas, and mopane woodland. It is used in conjunction with knapsack teams especially where the country is very broken.

4.6.1 Composition of a field unit

1 Unimog with insecticide tank and spray pump with two lances

1 Unimog with water tank, supplying water for making fresh spray liquid

- Staff

1 unit leader

2 drivers

2 spray operators

1 assistant to the water Unimog driver

1 'front man', normally locally recruited.

Several such units are used together in the field.

4.6.2 How the unit operates Under the direction of the unit leader, the driver follows the spray lanes already cut (see 4.9.3). He drives the spraying Unimog at 2 km/hour in gear N.2. This allows spraying to take

place over a distance of 2.9-3.5 km. of spray lane, taking 45 minutes to 2 hours, to spray one tankful (750 l.) of insecticide.

A power take-off device from the Unimog drives a pump which works at 2-2.4 Atm. with D.D.T., or 1.7-2 Atm. with D.D.T.-dieldrin mixture (1 Atm. = 1.033 kg/cm²). The pump drives spray mixture through two lances, controlled by spray operators sitting at the back. These operators direct the spray on to woody vegetation to either side of the spray lane. The distance to either side that the spray can reach is between 4.5 m. and 7 m. depending on the wind direction.

4.6.3 Spray lane cutting Spray lanes have to be cut through the bush to allow Unimogs to reach the areas to be sprayed.

For effective lane cutting the team leader will study:

- printed maps of the area
- the survey map already drawn up
- the survey report
- the area itself by inspection

He will have been fully informed of the boundaries of the spray area, by the senior officer, and will have received instructions on the general plan of the route to be taken by the spray lanes.

The leader of the spray lane cutting team will work out:

- how large the area to be covered is, and what labour is needed
- transport needs, to take gang to working area
- when the work has to be done, knowing the dates on which spraying is due to start.

Under normal conditions 5.6 km–8 km (average 6.8 km) of spray lane have to be cut per km² of area to be sprayed.

For example, if the area to be sprayed is 388 km², then in average country there will be

$$\begin{aligned} 388 \times 6.8 \text{ km of spray lane to be cut} \\ = 2638 \text{ km.} \end{aligned}$$

Spraying covers the area quicker than spray lane cutting. For example average rates may be:

12.8 km/day for lane cutting team

16 km/day for spraying team

Therefore spray lane cutting will start about one month before spraying.

Spray lanes should be at least 2.2 m. (8 feet) wide, and with 2.6 m. (10 feet) head clearance.

Holes in the ground are marked with sticks.

Stumps should be removed or flattened, to avoid causing punctures.

4.6.4 Where to cut the spray lanes The spray lanes will be cut or marked:

- around drainage lines, as this covers much of the tsetse habitat and avoids difficult gulleys and ravines. Also thicket edges, dambo edges, wood, under and around water holes.
- into certain places that look as though they may be supporting a tsetse infestation, even though the survey had not reported any.

4.6.5 Spray lane burning After spray lane cutting, the grass is fired. This is done in order:

- to expose tree trunks for the more effective application of spray
- to clear the view of the ground for the benefit of Unimog drivers
- to reduce the chance that cattle may eat the grass after spraying, and so take in insecticide
- to remove grass that would burn after spraying and so destroy some insecticide on trees, shrubs, etc.

Burning should be carried out 2 or 3 days before spraying.

Full co-operation with local leaders is essential so that the reasons for burning are understood, and no damage to crops or other property is caused.

4.6.6 Daily reports A daily report (spraying log book) is written up by each field unit leader. It will show:

- Time of start and finish of each tank used
- kilometer readings at start and finish of each tank used
- type, concentration and quantity of insecticide
- names of unit staff
- brief description of country sprayed during the day
- mechanical state of vehicles, pumps, etc.
- map indicating the lanes sprayed

These daily reports are essential for writing the end of season report, and for analysing the reason for the survival of fly pockets.

4.6.7 Insecticides 5% D.D.T. w.p. is used for the first part of the dry season. From September onwards, where this spraying technique is used, a mixture of D.D.T. and dieldrin (3.8% D.D.T., 1.8% dieldrin) gives better persistence after the start of rains in November/December.

Dosage is variable, depending on the thickness of the vegetation, but in average country a Unimog might cover 16 linear km/day i.e. approximately 2 km². Assuming that five tankfuls, each 750 litres of 5% D.D.T., are sprayed, this gives a swath dosage of 900-1000 g. D.D.T. a.i./ha, and at 12% discrimination the overall (area) dosage would be 100-200 g/ha.

4.6.8 Comments on the method The method as described is effective, but

- a) it depends on complex machinery being kept in good order
- b) it usually results in a higher application of insecticides than knapsack spraying
- c) much of the insecticide sprayed does not land on the woody vegetation target, so that there is undesirable contamination of the environment
- d) it cannot be applied in very broken country.

4.7 PLACEMENT AND SPRAYING OF ARTIFICIAL SCREENS (TARGETS)

4.7.1 Research and development

From the earlier days of tsetse control there has been considerable interest in the use of impregnated screens either of manufactured fabric or of animal skins. For use in tsetse control operations these screens were sprayed with persistent insecticide, formerly DDT or dieldrin but more recently deltamethrin.

Workers in West Africa found that a particular blue dye was attractive to tsetse fly, and used cloth of this colour in the construction of the biconical (Challier-Laveissière) trap, and later in the design of impregnated screens.

However, it was the use of electric screens (=electric traps) as a research tool, which enabled research workers to analyse rapidly and conveniently the relative attractiveness of different colours, odours and trap designs. The electric screens are made of fine wire, which are invisible to the tsetse fly. Placed over cloth screens of different colours, and near to sources of different odours, they electrocute flies coming to such colours and odours. The flies so killed can be counted, helping the investigator to select whichever attractant is most effective. This information is then used to design odour-baited screens (=targets) which can be sprayed with insecticide and placed at strategic points in the field.

Targets so far designed are known to be particularly effective against Glossina pallidipes and G. morsitans, and insecticide impregnated blue cloth screens have been used against riverine tsetse (palpalis group). It must be emphasised that target technology is relatively new, and still being developed. It is unsure how suitable the odours used will be to attract tsetse flies in parts of their range beyond the areas in which trials have been carried out thus far. It will be

necessary to carry out tests, such as small scale pilot trials, to see how effective such control measures may be in these other areas. It is likely that different odours (or combination of odours) will have to be identified for use against each different species of tsetse fly. Similarly, different colours and trap or target designs may be found to be necessary for use against the various tsetse species.

4.7.2 Equipment

The method is still under active development and the following mentions only a few of the devices that are being used:

i) West African trials

Insecticide-impregnated biconical traps and other designs have been successfully used to give very substantial reductions in fly numbers in riverine fly populations. For instance, 1100 biconical traps each sprayed with 400 mg a.i. of deltamethrin, have practically eradicated G. palpalis and G. tachinoides in a 1 700 km² area of northern Ivory Coast.

A mono-pyramidal trap of blue or black material, and made up to different sizes, has recently been under trial. A small version of this has been sprayed with deltamethrin at 125 mg a.i. per trap, and resprayed every two months. This led to a collapse of the fly populations to close to zero.

Screens of blue and black colour and "flags" of blue cloth 70 x 110 cm treated with deltamethrin, endosulfan or other insecticide have been on trial in West Africa against G. palpalis and G. tachinoides. Bioassay showed good persistence for deltamethrin, even under rainy conditions. Other synthetic pyrethroids are under trial.

Such screens or impregnated traps can be used against palpalis group species, spaced out at 150 - 300 m intervals along the riverine habitat.

ii) Southern African trials

Undoubtedly some of the most promising work has been the development of screens baited with artificial odours (targets). A very attractive chemical substance is carbon dioxide, but except for research purposes this attractant is not convenient to use in the field. It has to be dispensed from very heavy cylinders, which bars it from use in general control and survey work.

Very effective odours at present in use are acetone (or as an alternative to this, methyl ethyl ketone), and octenol (=1 octen-3-ol). Under investigation are some phenolic derivatives (e.g. p-cresol) to be found in cattle urine. It is likely that several of these substances will be used together to enhance the attractiveness of targets (and of traps).

In Zimbabwe target trials have been conducted on a large scale. For instance, in a 600 km² triangular area bounded by the escarpment below Makuti on one side, the Zambezi River on the second side, and the main road from Chirundu across the valley floor to the foot of the escarpment on the third side, 2 400 targets were erected. This area, the Rifa triangle, is a game reserve and well wooded, an ideal habitat for tsetse flies. Pre-trial surveys showed a heavy infestation of both Glossina pallidipes and G. morsitans. After a year the G. pallidipes had virtually disappeared, and G. morsitans was reduced to very low numbers. A sentinel herd of 20 cattle placed at the foot of the escarpment, and half way along it, have given no definite cases of trypanosomiasis.

One commonly used design of target has a black cloth square, flanked by two rectangles of black netting. These pieces of material are held within a simple wire frame, which itself is mounted on an eccentric pivot (i.e. the frame is free to rotate on the upright pivot; but the pivot contacts the frame to one side of centre). The area selected to "plant" a target

is cleared of vegetation by hoes and spades. The pivot is hammered into the ground, and the frame suspended on it ensuring that the frame can swing freely. The cloth and netting is then sprayed with deltamethrin 0.1%, from a knapsack sprayer. Enough is applied to ensure thorough wetting, but spraying should stop before there is significant run-off.

In the ground, near to the pivot, bottles of octenol and acetone are placed, Octenol is dispensed in used injection phials (having a silicone rubber cap), which are placed in an inclined position so that the octenol remains in contact with the rubber cap and is able to diffuse slowly through it. Acetone is dispensed in 250 ml containers with a 6 mm hole drilled in the screw cap, allowing the acetone vapour to escape. The two bottles may be fastened to each other by wire.

As in all cases in which traps and targets are used, a map is marked to show where each is placed in the field, and a record kept of its date of installation, and of any servicing it may receive after installation. A hard covered pocket notebook is suitable for keeping these records.

It is emphasised again that these odours were developed principally for use against G. pallidipes and G. morsitans. They may be far less effective against other species. A great deal of development and testing remains to be done.

4.7.3 Insecticide

Deltamethrin is the insecticide of choice because of its extreme toxicity to tsetse flies, and its harmlessness to mammals at the concentrations and dosages used. It is however very expensive. It is supplied at present as 18.75 or 20% suspension concentrate, and is used as a 0.1% or 0.05% spray liquid. Respraying may have to be done once every one or two months. A new formulation has been developed specially for tsetse control, that incorporates a

chemical to counter the effect of ultraviolet rays from the sun, which is in part responsible for the rather rapid breakdown of the insecticide active ingredient. Bioassay on the insecticide residues will be particularly valuable and necessary in the years ahead during which this relatively new technique will be tested under new environmental conditions.

There are currently trials in the use of a formulation of endosulfan permitting the slow release of the insecticide. The use of a formulation of cypermethrin for ground spraying and for screens is being investigated.

4.7.4 Maintenance of screens, logistics

Screens (targets) may have to be resprayed every two months, or even more frequently, with a 0.05% deltamethrin. Samples of the impregnated cloth must be subjected to bioassay tests to find out how quickly its toxicity is being lost, and thus how frequently the targets will have to be resprayed.

It has also been found that the black colour of the cloth can fade to a mid grey which is much less attractive to the tsetse flies, so that the target as a whole is less effective. Upon signs of fading, the cloth must be resprayed with a suitable colour-fast black pigment.

Visits to service the targets will also be opportunities to check acetone and octenol levels and the reserves of any other odour attractants in use with the targets. Spares of cloth and cloth netting will be carried so that damaged parts can be replaced. Regrowth of plants around the targets will have to be slashed.

For ease of servicing the targets, some access roads may have to be re-opened or slashed. Insecticide will be dispensed from pressurised knapsack sprayers.

4.7.5 Design of eradication schemes using targets

- a) Block treatments. The planning of where to place lines of targets will to some extent resemble the planning of ground spray operations. They should be placed along drainage lines, and within woodland known or believed to be fly habitat. Exactly where the target lines should be, can be decided with the help of aerial photographs, and by reference to the previous survey maps.

It may be specified, from budget considerations, that targets should be placed at an average of (say) 4 per square kilometre, but it is unlikely that an even distribution of targets is the most effective. Instead, targets should be concentrated:

- along areas believed to be favoured tsetse habitats;
- along fronts expected to be under heavy re-invasion pressure (see below)

Targets should not be placed on hilltops or in extensive grassy areas, away from the main fly habitat.

As in ground spraying, access roads will have to be cut, for the purpose of planting the targets in the first place, and in servicing them at intervals afterwards.

- b) Holding lines, used in conjunction with other control methods. In principle, rows of targets can be set up to act as barriers against re-invasion into an area cleared by aerial spraying. Such barriers, or holding lines, are under study at present. One arrangement might be for the holding line to consist of several (4 or 5) rows of targets

the targets themselves being placed 100 m or 200 m apart, with the distance between rows being about 400 m. The position of targets should be staggered to increase the chances of invading flies encountering one.

Thus the depth of the holding line could be up to 2 km. Since such a holding line will not take immediate effect, it should be in place well before its full impact is needed. For instance, if a target holding line is to protect an airspray exercise, it should be set up months before the airspray programme, even during the previous dry season.

The degree to which a target holding line will be "fly-tight" will depend not only on the care with which the targets are placed in the field, but on the efficiency with which they are serviced (see previous section).

4.8 SURVEY METHODS

Survey for tsetse fly, or finding out where flies are, is a vital part of the field workers' function.

It is hardly possible to start any tsetse control operation without some knowledge of the fly distribution in the field, and after such an operation is concluded, it is essential to know if flies remain in the treated area, and if so, exactly where and in what numbers.

The worker may have to report on the identity of the tsetse species that are present, and on which type of habitat is particularly subject to fly infestation. His reports may therefore have to describe vegetation cover, drainage lines, rocky outcrops, game animals, domestic animals and human settlements, all of which could influence the suitability of the area as tsetse habitat. However, the present description of

tsetse survey does not deal with the very detailed type of survey work required to investigate the development potential of the surveyed land, not just the extent of tsetse infestation.

4.8.1 The sampling methods available

The basic task of the surveyor is to find if tsetse flies are present in an area. To find flies he may use one of several methods. It is recommended that trials be carried out in the work area to see which methods are effective and convenient to use.

- (i) Man fly rounds. A team of two or three men may patrol through the area being surveyed. They will be equipped with hand nets, a notebook, pencil, and map. Their working hours will be arranged according to season, but in most seasons an early morning and late afternoon patrol is likely to be the most productive. In the cold season patrols in the middle of the day are preferred. The work will proceed by the team walking about 100 or 200 paces, stopping for a few minutes to catch fly and recording the catch as to species, sex, and perhaps whether teneral or non-teneral. Longer stops may be needed where fly is scarce, but believed to be present. To detect species such as G. tachinoides, particular patience has to be used, and the catching party may need to sit and rest quietly, waiting for flies to come to feed. If species identification is difficult, a hand lens may have to be carried by a member of the team.

This method of fly survey has been widely used but is not efficient. Much greater efficiency is achieved by the man using a black screen and odour attractants (see below), at least when surveying for G. pallidipes and G. morsitans.

- (ii) Man fly rounds with black screen and odour attractants. In this method, used particularly in southern central Africa in G. morsitans and G. pallidipes areas, two men in the 3-man team carry a pole 3 m long, from which is suspended a black cloth screen 1.2 m x 2 m. Also suspended from the pole is a small bottle (c 250 ml) containing acetone. The bottle is used either open or with a wick in the top. Waste of acetone by spilling should be avoided.

For the sampling of G. morsitans and G. pallidipes populations this method is several times more effective than using men alone, and approaches the efficiency of ox fly rounds (see below). Other odour attractants may be tried, including octenol and p-cresol. The field of odour attractants is rapidly developing, and supervisors should take note of current developments to ensure their survey teams are equipped with the most effective odours available. Odours attractive to other species are under investigation.

- (iii) Bait ox, accompanied by two men. This is the standard means of conducting fly rounds for savanna flies, and for *Fusca* group flies when needed. It is effective, and a team may cover 100 Km² in one month's work. Disadvantages are that water and fodder have to be provided for the oxen; patrolling oxen through lion and hyaena infested bush can be hazardous for the oxen and staff, and in such country special security precautions have to be taken at the camp site. Oxen have in any case to be protected against trypanosomiasis by drugs. Transporting oxen from their usual herds to the survey site and back will require a lorry or trailer.

- (iv) Stationary traps. Different designs of traps are available. Currently the biconical trap of Challier and Laveissière is widely used to sample populations of Palpalis group flies, and of G. pallidipes in Somalia. A blue box trap baited with acetone, octenol and various phenols is remarkably effective in trapping G. pallidipes and slightly less effective in trapping G. morsitans, in Zimbabwe, but so far has appeared to be somewhat less effective in other countries. Group leaders are urged to try out the various trap designs and odour baits in their own countries, to assess which might be the best for their survey teams. Cheapness of construction, and ease of transportation are important considerations in such a choice.

Traps have been placed in the field and sprayed with insecticide, so as to act as control method. It should be recognised that the slight repellent effect that an insecticide deposit might have, would reduce the effectiveness of such traps as a survey method.

The use of traps normally require motorised transport, to place them in the field, to harvest the catch, and to recover them after use. Given such transport, traps can assist in surveys for flies over extensive areas fairly quickly. Traps may be particularly useful in monitoring a spray block for survivors, and for assessing the extent of a known pocket of survivors.

- (v) Vehicle mounted electric trap (VET). A pickup may be equipped with electric traps arranged vertically either along the centre line, or flush with the sides of the vehicle. If the latter, the vehicle has to be restricted to relatively wide tracks where there is no

danger of the fringing vegetation damaging the electric traps. A small electric trap mounted on the back of a motor bicycle is at an experimental stage at present. Bait odours may be used in conjunction with the VET. The vehicle is driven slowly (10-15 Kph) for about 1.5 km before stopping for a few minutes. Electrocuted flies should be collected and stored each time the vehicle stops, for the purpose of recording the site of capture.

At present there is little information concerning the value of VETs for surveying species other than G. morsitans and G. pallidipes.

- (vi) A special method of survey is sometimes used for detecting G. austeni (and more rarely for other species) and that is pupa searching. Glossina austeni and most Fusca group flies come very rarely to traps and surveys teams. Pupa searching can reveal their presence even though adults may not be seen.

The above are methods for detecting fly or pupae directly. However, the presence of tsetse can be detected indirectly by the records of cattle trypanosomiasis. In many parts of Africa, reports of cattle trypanosomiasis can be taken as an indication of the presence of tsetse fly. This is specially true for places where up-to-date and sensitive methods of fly survey are not yet in use. Unless flies have been carefully looked for, using these improved methods, it is unsafe to ascribe the occurrence of trypanosomiasis cases to mechanical transmission (i.e. to tabanids, Stomoxys or other blood sucking flies) rather than to cyclical transmission by tsetse. If cattle trypanosomiasis occurs, the presence of tsetse flies should always be suspected, unless it is a clear case of cattle being brought to an area from or through a tsetse zone.

In certain places beyond the northern limit of tsetse, there may be many more cases of genuine mechanical transmission, as the numbers of other blood sucking flies there may be very great.

It has always been recognised that around the well-established fly belts, there is a zone of high risk for cattle to contract trypanosomiasis. Such high risk zones may be due to cattle movements occasionally bringing livestock close up against and main fly belt, or due to the feeding activities of occasional carried and immigrant fly. However, given improved methods of surveys it is very likely that many of the high risk zones will be found to be permanently populated by low densities of fly, previously undetected because inadequate methods of survey had formerly been used.

Placing sentinel herds of cattle in areas cleared of flies, provide a means of verification that fly really has been exterminated. The cattle are not given prophylactic cover, but are examined regularly for trypanosomiasis. It is sometimes said that if cattle can live in an area for five years without contracting trypanosomiasis, it can be assumed that the immediate area is free of tsetse flies.

4.8.2 Recording the flies caught

All flies caught are recorded on a record sheet, noting species and sex. A record sheet will be designed with headed columns ready to be filled in. The vegetation type at each stopping point will also be written down. At the end of the day's work the route taken by the catching party will be pencilled in on a 1:50,000 map and the places at which each fly was caught will be marked in using a coloured pencil. According to procedures in use in particular countries, different colours may be used to indicate the point of capture of different species of tsetse. If there is any doubt about the significance of the colours used, then a key showing the colour against the species indicated, must appear somewhere on the map.

Each day's patrols will be recorded on the map, and a picture of the distribution of the fly in the whole area will be assembled. Survey camps will have to be moved frequently (say every three or four days) as the immediate area around the current camp site becomes sufficiently surveyed. A team should be able to survey about 100 km² in 20-22 working days. A neater version of the month's survey results may be drawn up at headquarters, and the results will also be transferred to a smaller scale map (say 1:250 000) so as to give a summary indication of the fly distribution as revealed by all the teams at work in that month and the months immediately preceding the current one. For areas where fly distribution is known to be very dense, not every single fly capture need be shown on the smaller scale maps, as this would be impracticable. Instead, a dense scatter of dots is marked in to show the heavy tsetse population. These smaller scale maps give an easily understood impression of where the main fly front is, where fly concentrations are to be found, whether there are pockets of surviving flies, and where fly appears to be absent. If more than one species are present in the area, their different distribution pattern should be apparent, due to the different colours being used.

4.8.3 Interpretation of survey results

The task of the provincial biologist or entomologist, and of headquarters staff, will be to interpret the results brought in by the survey teams. Their approach to this task will depend in the purpose behind the survey.

(a) To assemble a national tsetse distribution map. All national tsetse control units should have a map showing the nationwide distribution of tsetse, for each species. It is possible that such a map will be very incomplete and in need of updating. Teams will therefore have been deployed to survey areas along the supposed edges of the fly belts. Improved methods of surveys might very well show fly to be more extensive than had been thought to be the case in the past. It is

a primary task of headquarters staff to keep an updated national map showing fly distribution. This map will frequently have to be referred to by specialists in other areas of rural development, such as agriculturalists, settlement planners and economists.

If it is intended to publish a printed National Tsetse Distribution Map, this map should show:

- the date of publication
- the location of the main fly belts, of the various species
- sufficient basic geographical information for a user to be able to know where the boundaries of the fly belts are, in relation to sizeable towns and villages, and the road network
- the location of geographical and ecological features which might be specially important in relation to fly infestation, such as swamp zones and other treeless areas, protected forests, game reserves, escarpments
- areas known to be sleeping sickness foci
- historical limits to fly spread
- significant climate isolines (e.g. average cold season temperatures)

It would be very helpful if a note in bold lettering would inform the user that the fly distribution pattern is not necessarily static, and that updated information is available at the relevant tsetse control office.

(b) To establish if there has been significant advance or retreat of fly belts. If a clear fly frontier can be seen on the 1:250 000 summary map, biologists should consult previous records to find if this front is stable, or if there has been any retreat or advance. If the front has been stable for some years, there is almost certainly an ecological factor causing the stability : for instance the line may correspond to an escarpment, or to a marked vegetational change on the ground.

If the fly front is instable, then again reasons have to be looked for. A general theme underlying many of the recorded fly advances of this century, has been the recovery of fly belts from the collapse following the rinderpest pandemic of 1890-95. A local fly advance recorded at the present day must be evaluated in the context of a possible post-rinderpest recovery. Previous records must be consulted, even those dating many years ago. These records may, however, show that this particular fly belt is subject to repeated advance and recession. Climatological data for the relevant years may suggest reasons for these movements. Alternatively, changes in land use by human populations may provide an important clue. Settlement might be pushing fly back; abandonment of previous inhabited areas might be allowing fly to surge back into areas that had been infested only many years ago. Such human evacuations might follow disease outbreaks, climatic disasters or political upheavals. The possibility that populations of flies might be adapting their feeding habits, from a dependence on wild animals to more (or even total) dependence on domestic livestock (in practice, cattle and/or pigs), has to be evaluated. If such a behavioural change is suspected, it might be thought worth mounting a special investigation into tsetse blood meals in the area of interest.

(c) To detect survivors from a control operation

Routine surveys in a supposedly cleared area (one that has been sprayed in recent years) might reveal a hitherto unsuspected pocket of fly. In such circumstances the discovery of even a single fly should be taken very seriously. A more intensive survey should be put into the locality immediately, and contingency plans made for a control campaign to eradicate the pocket. The means selected for eradication is less important than the speed with which the problem can be tackled. The biologist should be aware that the single fly caught might be the first indication of a considerable pocket of fly several square kilometers in extent, and that any delay in its eradication might end in the infested area being multiplied many times, leading possibly to total failure of control. On the other hand the insect may be an isolated carried fly and pose no special threat to the area, but rapid verification is needed. The most sensitive methods of fly survey are required in such situations, and it is better to over-react than to risk a major setback.

CHAPTER 5

CONTROL AND ERADICATION OF TSETSE BY AERIAL
SPRAYING
(AND FOGGING)

5.1 INTRODUCTION

Applying insecticides from aircraft has been carried out on a large scale for tsetse control in some countries, e.g. Botswana, Zambia, Zimbabwe, Nigeria and Somalia.

The aircraft have to be fitted with insecticide tanks, spraying equipment, metering and recording apparatus and navigation aids. The personnel are highly trained and pilots must be especially experienced in flying at just above tree top level for long periods, often in twilight conditions or at night.

The following notes are not intended to give full details of the pilot's work, but enough information is given so that those working on the ground can understand how the operations are run.

5.2 AIRCRAFT AND THE MAIN TYPES OF AERIAL
SPRAYING

There are two main types of aircraft used in tsetse control:

- a) Fixed wing aircraft, preferably with two engines
- b) Helicopters

Fixed wing aircraft are used mainly against savanna tsetse (Glossina morsitans, G. swynnertoni and G. pallidipes). They operate best in flat country and can cover a great deal of land very quickly. They use airstrips as close as possible to the area being sprayed. Ground staff assist in monitoring the accuracy of flying and the distance between flight paths (see 5.3.4), as well as monitoring the fly population in the spray block.

Helicopters are in use against palpalis group flies, and against mixed infestations of G. morsitans and palpalis group flies, concentrated along drainage lines. Two kinds of operation are possible:

- a) Eradication schemes in Northern Guinea and Sudan savanna.
- b) Control schemes in Southern Guinea savanna vegetation areas, to reduce quickly the tsetse population in areas in which sleeping sickness is present.

Helicopters use several small landing bases (helipads) cleared for the purpose, near the sites to be sprayed. Helicopter spraying is generally more expensive than using fixed-wing methods (per unit area of land cleared of tsetse), but needs less ground staff. It can more easily be deployed to spray small areas e.g. residual foci of infestation.

5.3 FIXED-WING AERIAL SPRAYING USING NON-RESIDUAL TECHNIQUES

5.3.1 Basic technique Concentrated insecticides (formulated in oil solvents) are applied in the form of aerosol droplets over the

whole area to be cleared of tsetse. The insecticide droplets penetrate the woodland canopy and remain in the air long enough to make direct contact with, and so kill, all the adult tsetses in the area, whether resting or in flight.

Several applications of the insecticide (spraying cycles) have to be made. It has to be remembered that in a given tsetse-infested area, there may be more tsetse below ground as pupae, than there are adult flies.

During the first cycle, the adult tsetses are killed. During the next few days, pupae present in the ground will give rise to young flies which must be killed before they are old enough to breed. Therefore the next spraying cycle must begin before the young flies reach maturity and are able to deposit the next generation of pupae.

Successive cycles are sprayed at 2-3 weeks' intervals (approximately) until all pupae have had time to turn into adult flies. In practice this means that at least four cycles have to be sprayed, and five or six may be necessary.

The aircraft flies to and fro across the spray block just above tree top level, so that each pass of the plane is 200-400 m. (depending on swath width, see 5.3.4) to the side of the path taken at the previous pass and parallel to it. During each pass, an aerosol insecticide formulation is sprayed over the area. A spraying cycle may take several days, depending on the size of the spray block.

If more than one aircraft is used, then the planes fly in formation, at one swath width intervals.

Since the aerosol insecticide very quickly loses its power to kill tsetse flies (it has little or no residual action), and the habitat is unchanged, there is nothing to stop rapid invasion of the airspray block from outside. It is therefore essential that a protective barrier to stop invasion be set up well before (months before) the airspray is due to start. A protective barrier might take the form of ground spraying, or a target campaign. In planning the location of an airspray block and the measures to be taken against re-invasion, consideration should be given to

- areas that are known from surveys to be free of fly
- natural barriers such as large water bodies
- the ability of ground spray teams or target placing teams to set up barriers to re-invasion from areas known to be infested.

5.3.2 Insecticide The insecticide used to date is endosulfan, which is supplied as a 20%, 30% or 35% concentrate in oil solution. It may be used in these forms, or diluted to 20% with a suitable solvent. With most solvents the droplet becomes smaller the longer it stays in the air, as the solvents evaporate. The formulations used contain a small proportion of non-volatile (non-evaporating) solvents, such as vegetable oils, to limit evaporation. This ensures that the final droplet size is not too small for impaction on the tsetse, and in the case of technical material which is a solid, it ensures that the final particle is not completely dry.

The insecticide is sprayed at the rate of 8-20 g/ha/cycle.

Although the insecticide is in concentrated form and is very toxic to tsetse flies, each droplet contains so little insecticide that it is non-residual, and disappears within a day or two of application.

Recently, trials involving deltamethrin have been carried out in Southern Africa, and have given encouraging results. Due to the extreme toxicity of deltamethrin to tsetse, even lower dosage rates have been used, than when using endosulfan.

Mixtures of endosulfan and pyrethroid insecticides have been used in aerial spraying in Botswana, in an effort to reduce the hazards that these insecticides pose to non-target organisms.

5.3.3 Spraying equipment Micronair rotary atomiser equipment is used to produce the aerosol droplets. Generally one unit per aircraft is used. Insecticide is pumped through a metering device on to a rotating gauze cylinder breaking the liquid up into droplets. The speed of rotation determines the drop sizes produced.

The gauze cylinder is passively driven by a small propeller fixed to the front of the micronair atomiser. As the plane flies, the slip-stream wind drives the propeller which can be adjusted for faster or slower spinning by altering the setting (pitch) of the 5 (sometimes 3) vanes of the propeller. The rate of spinning cannot be adjusted in flight, but it can be stopped by a brake.

5.3.4 Flight interval, swath and droplet size The band of insecticide droplets in the air is the swath. The width of the swath should be greater than the flight interval (the distance between parallel runs of the aircraft). Under ideal meteorological conditions the swath is much wider than the flight interval and any place within the sprayed area is therefore covered by several bands of aerosol.

The droplets should be approximately 30 μm . in diameter or rather less. Droplets can be examined by putting out magnesium oxide coated microscope slides in the spraying area for later examination. These slides can be slotted into a bracket, driven by a small electric motor (the type that is used to drive small toys and powered by a battery), so that they rotate and collect droplets by impaction. Droplets hitting the magnesium oxide coating on the slide can be seen as round craters, when the slide is examined through a microscope. Their size can be measured using an eye-piece graticule (the Porton graticule).

These methods can be used to check the swath width as well as the type of droplets being produced.

5.3.5 Ground marking and navigation It is essential that there should be some method of making sure that each pass made by the plane is parallel to and at a correct distance from the previous pass. For this, a ground marker is needed. Usually, before the spraying starts, a marker line is laid out. This may be a track cut through the bush and made wide enough for a four wheel drive vehicle to move along it; or a suitable road may already exist. Wooden pegs are placed along this marker line at intervals (e.g. every 200 m. or 300 m.) corresponding to the places over which the plane is required to

make its passes. The pegs are numbered appropriately, and indicated on the spray block map.

The team on the marker line assists the pilot by revealing its own position on the ground. Various methods are used: brightly coloured discs on long poles, smoky fires, Verey flares, and lamps on telescopic masts have all been used. The marker line vehicle is usually painted white so that it shows up well. Methods will vary according to whether flying is by day or by night.

As the plane passes overhead, the marker team will note whether the plane is sufficiently close to the required position. If the plane is off course, then the pilot will be requested (by radio) to repeat the run. If the plane is on course, the marker team then moves on to the next marker and the procedure is repeated for the return pass.

If the spray runs are short, the pilot may be able to keep his runs straight using just a compass. If the spray runs are very long (50-80 km, for example) more complicated navigation apparatus will be needed on board. Decca Doppler or Global ULF electronic guidance equipment have been the main instruments used so far. A recent advance has been the use of a TANS computer in conjunction with the Doppler system.

Preferably there should be a marker line at each end of a spray block, so that the plane's position can be checked at or near the start and finish of each run. For exceptionally long spray blocks, a third marker line near the middle is useful.

During a run the pilot has to concentrate on keeping a straight course and on

keeping the plane at the right height above the tree canopy. At the end of a run he switches off the spray system, checks with the marker team on the success or failure of the run, resets the navigation system for the next run, brings the aircraft round to the correct position and switches on the spray system. This process continues until the plane has to land for refuelling or refilling with insecticide.

If more than one plane is used, then the lead plane flies by its own navigation equipment and by the marker line, while the following planes concentrate on keeping formation with the lead plane.

5.3.6 Timetable of spraying As explained earlier, the insecticide acts directly on the adults. It does not affect pupae below ground. When flies emerge from these pupae there is a period of time (usually 2-3 weeks) before they are sufficiently mature to be able to deposit larvae. The next spraying has to be carried out before these flies are able to reproduce.

5.3.6.1 Meteorology The actual interval of time between one spray cycle and the next will depend on the temperature, as this affects the time from emergence to deposition of the first larva. In the cold dry season the interval will be longer than in the hot dry season. Spray cycles continue until it is judged that all pupae have had time to produce adult flies.

The temperature should therefore be checked daily, and revisions of the spraying timetable will be made accordingly (see Mulligan 1970, p. 353). Also if available, newly deposited pupae may be placed in small cages buried at suitable points in the habitat, and the date of emergence of the flies checked (see Volume 1, 7.1.7).

Field operations can begin soon after the rains have stopped, when the air-strip and marker line are dry enough to use. In some regions a cold dry season is followed by a hot dry season. Endosulfan is known to be more effective at higher temperatures. The tsetse population is probably at its most vulnerable to aerosol attack at the change from the cold dry season to the hot dry season, because at that time the emergence rate is at a maximum, the adult population is very young, the number of insecticide-dose tolerant pregnant flies is at a minimum and the number of pupae in the ground is relatively small. For these reasons an aerosol campaign is likely to be most effective if started at the beginning of the hot season, but due to the long period of time needed to complete an airspray, a start in the cold season may well be necessary.

Spraying is done during hours in which there are inversion conditions (Volume I, 10.2.1). At such times an aerosol spray will not be carried away on thermal up-currents and so be wasted. This requirement restricts the flying time to the period from about one hour before sunset to about 1.5-2 hours after dawn. The best spraying conditions occur at night, but aircraft have to be equipped with powerful lights for spraying at night, and it is obviously more dangerous than daytime flying. The demands on pilot skill are greater than for daytime flying. If night-time flying is possible, then much larger spray blocks can be covered.

5.3.6.2 Dissection of flies caught within the airspray block A very important activity on the ground is the sampling of the tsetse population within the spray block, and the dissection of the captured flies for ovarian analysis. Sampling maybe done by any of several available

methods: man flyrounds with screens and odour attractants, odour baited traps, vehicle-mounted electric traps, and bait ox patrols. All females collected should be brought immediately to a field camp for dissection.

The work of the dissection team should help the biologist in charge first to check whether the timetable of spraying needs adjustment, and second to judge whether a given captured female fly is likely to have been a survivor of an earlier spraying or not.

Let us consider the following types of captured fly, and the implications of their capture.

- 1) A female fly that is caught on the morning after the first spray cycle; on dissection the fly is found to be an old fly (i.e. pregnant, or parous = one that has already given birth). This older fly might be a survivor (pregnant females are known to be particularly refractory to endosulfan, compared with teneral flies and males), or it might be a fly that has received a fatal dose of endosulfan, but has not yet succumbed to the insecticide.

Action: Sampling of the tsetse population must immediately be intensified, and if more old females are found that cannot be discounted as immigrants, then it may be assumed that significant numbers of pregnant females are surviving the first cycle. An extra spray cycle

could be interpolated, timed to coincide with the day on which surviving females may be expected to be without larvae in the uterus, and thus more vulnerable to endosulfan.

- ii) A female fly that is caught a few days after a spray cycle; on dissection the fly is found to be category 1, and with an egg in the uterus. If a fly is found in this state, it indicates that the next spray cycle must take place very soon, as in a few more days this fly would have reached the late pregnancy stage, which is more refractory to endosulfan.

Action: The next spray cycle should be run soon.

- iii) A female fly that is caught after the spraying programme is well under way; on dissection it is found to be an old fly (say ovarian category 2). The circumstances of the capture of this fly must be carefully examined. If it had been caught off a vehicle, or close to the periphery of the spray block, it might safely be regarded as an immigrant. If it is taken deep within the spray block, it should be regarded as a survivor. Its point of capture should be carefully marked on a map, along with any other similar captures.

Action: If a number of such flies are caught in a particular area (such as a valley or thicket), the possibility of sending in a ground spray team should be urgently considered. Such captures could signify that a pocket of fly was being missed by the aerosol, and that specific action has to be taken against that pocket before it can spread.

5.3.7 Ground activities These may include:

- a) Survey and fly rounds carried out before, during and after spraying both within the spray block and outside.
- b) Dissection of flies caught during surveys and fly rounds, to determine age and pregnancy state of survivors, rate of development of flies emerging between spray cycles, and length of pupal period (see 5.3.6.2).
- c) Clearing the airstrip of long grass, termite mounds, holes and other obstacles. Clearing trees from land at either end of the airstrip.
- d) Ensuring adequate and timely supplies of fuel and insecticide from stores to the airstrip.
- e) Marker line cutting.
- f) Insecticide mixing, and disposal of wastes (see 3.8 and 4.2).

- g) Meteorological observations (see Volume I, 10.2).
- h) Droplet size assessment and swath width measurement.

Other activities such as manning the marker line will be the direct responsibility of the senior office in charge.

5.4 FIXED-WING AERIAL SPRAYING USING RESIDUAL INSECTICIDES

These have been carried out mainly on an experimental basis in the past, during the development of the non-residual technique. D.D.T., B.H.C., dieldrin and occasionally other insecticides have been used. The method is not used at present.

5.5 HELICOPTER APPLICATION OF NON-RESIDUAL INSECTICIDES

This is at an experimental stage and shows promise for use in emergency sleeping sickness situations. The method has also been used for spot spraying of areas within an airspray block (fixed wing) where survivors have been detected. Endosulfan, deltamethrin, permethrin, fenthion, azamethiphos and tetrachlorvinphos have been tried against Glossina tachnoides.

The method is not widely used because of the high cost, although control campaigns have been carried out in Nigeria and Cameroun.

5.6 HELICOPTER APPLICATION OF RESIDUAL INSECTICIDES

5.6.1 Advantages of the method In these campaigns the insecticide is intended to be sprayed on to the resting places of the tsetse flies. The aim is therefore similar to that in ground spraying, but the resting places that are sprayed are different. Ground spraying deals with the daytime resting places on tree trunks and branches, etc., but helicopter spraying puts a residual insecticide on to the twigs and upper surfaces of leaves which may be used as night time resting places of tsetse.

The advantages of helicopter spraying over ground spraying are that helicopters can cover the ground much more quickly, and can spray areas that ground teams may find difficult to reach. On the other hand, helicopter spraying is more likely to cause contamination of rivers and the environment generally. Helicopters are better able to follow the winding course of rivers, than can fixed-wing aircraft.

Ground spraying is better than helicopter spraying for laying down chemical barriers to prevent reinfestation.

5.6.2 Insecticides These have been mostly D.D.T., dieldrin, B.H.C. and endosulfan, but others have been tested on a trial basis. Only dieldrin and endosulfan are currently used.

5.6.3 Spraying equipment The helicopter is normally fitted with disc atomisers mounted on booms.

5.6.4 Swath width and droplet size The swath width may be from 20-30 m. A narrow swath width is useful in dealing with gallery forest,

to avoid contamination of the river, as far as possible.

Droplet size in general use is approximately 150 um. diameter for residual sprays.

In West Africa the Harmattan may cover vegetation with dust so that insecticide residues are not as effective as expected.

5.6.5 Navigation Navigation is by eye, assisted by compass and maps. The helicopter has to follow winding rivers in country that may not be well mapped. Aerial survey may be essential before the main work starts. The pilot may require the assistance of a navigator to help him find the correct route and to avoid spraying the same area twice. This is a useful safety measure and greatly reduces pilot fatigue, but the insecticide load that the helicopter can carry is much reduced.

5.6.6 Ground activities Many landing spots for helicopters may have to be cut and a rough road made for the workshop lorry, for camp supplies, and supplies of insecticide, fuel and water.

As for fixed-wing aerial spraying, there have to be careful surveys made before, during and after spraying. Ordinary fly-round patrols may be used, or traps.

Ground activities also include:

- a) keeping up adequate supplies of fuel and insecticides to the base camp,
- b) insecticide mixing (see 3.8) and disposal of wastes and washings (see 4.2),

- c) keeping meteorological records (see Volume I, 10.2) and mapping the progress made.

5.7 FOGGING

A blast of hot air into which insecticides are injected, produces an aerosol. Ground based machines such as T.I.F.A. and Swingfog have been used to make aerosols for tsetse eradication. There have been some successes on a small scale, but it is not a method in use at present.

The main difficulties are in getting the smoke to spread evenly throughout an extensive habitat, under variable conditions of wind. The principle of attack is rather like aerial aerosol application, but the problems of moving about on the ground are much greater.

CHAPTER 6

OTHER POSSIBLE EFFECTS OF INSECTICIDES
USED IN TSETSE CONTROL

6.1 AREAS AT RISK

Insecticides used in tsetse control may have unwanted effects on man and other organisms (non-target organisms), and could damage the environment.

The following are the main areas at risk:

- a) People employed in the handling of insecticides; for example, spray operators, people who mix the insecticides, pilots.
- b) The general population, through the contamination of food and food crops, or by accidents.
- c) Domestic animals, such as goats, sheeps and chickens.
- d) Fish, birds and wildlife generally.

6.2 KNOWN WAYS IN WHICH INSECTICIDES CAN BE
DANGEROUS TO MAN

- a) Failure to label containers correctly
- b) Use of the wrong kind of containers
- c) Failure to wear proper protective clothing
- d) Contamination of food. This is not generally likely to happen in tsetse control as insecticides are not sprayed on food crops in these campaigns. The most likely food to be contaminated is that collected immediately after spraying and preserved for future eating (e.g. fish preserved for drying).

6.3 DANGER TO WILDLIFE (see Table 6.1)

The types of wildlife most likely to be affected are:

- a) Certain species of insectivorous birds. The populations of some species remain depressed over long periods; other species practically disappear.
- b) Cold-blooded vertebrates (reptiles, amphibians, fish). Large-scale mortality in fish in shallow slow-flowing streams has been found after application of endosulfan and dieldrin (at 800 g/ha and higher).
- c) Invertebrates such as non-target insects may also be killed in large numbers after these applications.

6.4 POSSIBILITY OF RECOVERY OF ENVIRONMENT AFTER DAMAGE

Not enough is known about the ecology of sprayed areas for us to say exactly what damage is being done, and how quickly the environment can recover from the effect of spraying.

A non-target species may be able to recover if survivors outside the sprayed area can easily re-invade the area. For example, along approximately 5 km. of a river in Niger where the fish population was severely affected by endosulfan applied at 800 g/ha repopulation was nearly complete after a year. Recovery would not be so quick if a very large area was so treated.

Hand spraying is more selective, and therefore less dangerous to the environment, than helicopter spraying. Areas that are at special risk should therefore be sprayed by knapsack sprayers rather than by helicopter. An area of special risk will be one in which fish form an important part of the local diet.

Table 6.1 Examples of environmental effects of pesticides used in tsetse control

Compound	Formulation; application technique; dose-rate if known	Main effects
D.D.T.	2.5-5% w.p. (75% D.D.T.); handspray	mortality in some birds, reptiles, amphibians, fish (low) and non-target insects
Dieldrin	180 g./l in Shellsol; 800-900 g. (a.i.)/ha ² ; helicopter	mortality and population depression in birds (especially insectivorous species), mortality in all other vertebrates (effects less pronounced with hand-spray application)
Endosulfan	200 g./l (25% ULV); 100 g. (a.i.)/ha; helicopter	mortality especially pronounced in cold-blooded vertebrates, acute mortality in non target insects, mortality in insectivorous birds
Endosulfan	aerosol treatment; repeated application 4x10 g. (a. i.)/ha; helicopter	no mortality in vertebrates; some mortality in non-target insects
Pyrethroids	aerosol treatments (repeated up to 5 x); dose rates in the order of 3 g. (a.i.)/ha	no mortality in vertebrates; slight mortality in fish; mortality in non-target insects and certain crustacea (shrimps)

Aerosol applications of endosulfan and pyrethroids involve less danger to warm-blooded vertebrates but fish and invertebrates may still be at risk.

The alterations to the general environment following settlement are likely to be very great, and at least for terrestrial organisms may perhaps be much more important than any damage directly caused by insecticidal attack. Altered land use is likely to involve clearing of bush, planting of crops, great reduction of wild game animals and the building of roads. All these will have far reaching effects on the original plants and animals, and may be irreversible.

6.5 MONITORING THE ENVIRONMENT

Checking to see if there is damage being done to the environment is called monitoring the environment.

6.5.1 Preliminary ecological investigation A regional ecological study should be made before any large scale tsetse control programme is started. A land use study should be made, and a survey of the characteristic animals and plants. The distribution and density of these species should be mapped, and information gathered on animal breeding seasons, and movements especially of the large game species.

6.5.2 Pilot trials This preliminary study should be followed by a small scale (pilot) trial spray programme, so that the possible effects of spraying can be monitored.

The following might form part of such a programme.

6.5.2.1 Chemical monitoring Samples should be taken from the environment (water, soil, plants, animals, man) before spraying starts, to check if there are insecticides already present (for instance from previous campaigns, or from agricultural operations).

The monitoring strategy will depend on the type of insecticide being used in the current campaign, for instance if it is expected to accumulate in fatty tissue, or if it is expected to alter its chemical nature after spraying or it is relatively non-persistent.

Sampling is carried out using metal or glass tools and containers. Samples should be stored at -20°C as soon as possible after collection. If there is no deep freeze available, samples may be preserved in organic solvents such as hexane or acetone. Each sample is kept in a separate container. Advice and information on techniques and materials should be obtained from the laboratory that is to carry out the chemical analysis.

6.5.2.2 Biological monitoring This may comprise:

- Checking the condition of health of spray operators. Subjective symptoms such as vomiting, loss of balance and painful eyes to be noted. Urine may be sampled for residue analysis.
- Checking the condition of domestic animals, noting morbidity and abnormal behaviour. Liver, brains, meat and milk may be sampled for residue analysis.
- Checking the numbers of organisms and species variety in the environment, the choice of organisms to be monitored depending on:
 - a) which insecticide is to be used, and how and where it is to be applied. For example, a persistent insecticide applied to tree trunks may be expected to have some effect on insects and spiders, which spend much of their time in such places, and on insectivorous birds that live at that level in the habitat.
 - b) The economic importance of some groups of organisms. Many fish species and shrimps are very important economically. Also important are protected wildlife species, pollinators (bees, some flies),

insectivores (birds, lizards and other insects), pest birds and insects (Queleas, locusts, plant-sucking bugs, caterpillars, other insect vectors, etc.), parasites (e.g. many flies and Hymenoptera).

- c) Ease of sampling. The animal species to be monitored must be fairly abundant, and easily observed or collected. From past experience a list of particularly useful species can be made up. These are known to be sensitive to insecticides and are called biological indicators (see Table 6.2). Fresh water mussels are filter feeders and can accumulate DDT from the water.

6.5.2.3 Sampling Strategy In order to be sure that a change in numbers of sampled organisms is caused by the insecticide treatment and not by other more natural causes it is necessary

- a) to sample control (untreated) zones at the same time as the treated zones. These zones should resemble the treated zone as much as possible. This resemblance should be demonstrated by prespray sampling over a long period (ideally for 3 years).
- b) To collect as many samples as possible from a wide area. From one place to another samples may differ considerably. By taking many samples from many sites in both the treated and the control area, changes due to insecticidal action may be detectable.

6.5.2.4 Sampling methods

- a) Mammals, birds, reptiles, amphibians. Any dead or dying specimens should be collected. Changes in populations can be studied by standardized counts (censuses). Repeated counts should be carried out at the same point at the same time of day by the same person. Post spray observations should be started from the very moment that spray operations begin.

Table 6.2 Organisms which can be used as biological indicators in studies on the effects of endosulfan, dieldrin and pyrethroids on the environment

Species	Dieldrin (residual)	Endosulfan (residual, ULV)	Pyrethroids (residual, ULV)
<u>Mammals</u>			
Tantalus monkey	+		
<u>Cercopithecus aethiops</u>			
Tree squirrels			
<u>Heliosciurus</u> spp.	+		
Fruit bats Pteropodidae		+	
<u>Birds</u>			
Flycatchers, genera: <u>Elminia</u> ,	+	+	
<u>Batis</u> , <u>Tchitrea</u> , <u>Platysteira</u>			
Robin chat <u>Cossypha</u> spp.	+	+	
Olive thrush <u>Turdus</u>			
<u>olivaceus</u>	+		
Riverin kingfishers:	+	+	
<u>Halcyon</u> spp. <u>Ceyx picta</u>			
<u>Cold-blooded vertebrates</u>			
Reptiles, amphibians, fish	+	+	+
<u>Invertebrates</u>			
Locusts: Orthoptera spp.	+		
Dragonflies: Odonata spp.	+		
Ants: Formicoidea spp.		+	+
Mayflies: Ephemeroptera	+	+	+
True flies: Diptera	+	+	
Crustaceans: <u>Caridina</u>			
<u>africana</u>			+
<u>Macrobranchium</u>			
<u>ravidens</u>			+

- b) Fish. Fish censuses can be carried out by electrical fishing, if equipment is available. Nets of various designs and mesh width can be fixed during standardised periods. The number of specimens/hour/m² of immersed net can be calculated.
- c) Insects and crustaceans. Flying insects can be sampled by Malaise traps (catching mostly Diptera and Hymenoptera) (Figure 6.1); water traps catch Coleoptera and Hemiptera (Figure 6.2); sticky traps (Figure 6.3) catch mostly small insects. Attracting traps (traps with a bright light, or with bait) can be used mainly in open sites. Animals (such as spiders, beetles and cockroaches) living on the soil surface are trapped by pitfall traps (Figure 6.4); as many as possible (30-50) of these should be used to catch a large enough sample. Insects living in trees can be caught in a beating tray. Insects can be taken from low vegetation by using sweep nets. An accurate but slow and tiring method of sampling low vegetation is to place over it a 1 m² bottomless cage, and collect all the animals within by hand.

Aquatic insects and crustaceans can be sampled by fine-meshed drift nets. A mesh of width 100 μ m is used for young instar larvae and copepods, and 1 mm. for crustaceans, insects and small fishes.

Sedentary (fixed) larvae can be collected by placing small concrete blocks on to an iron base, which act as surfaces to which the larvae fix themselves. The blocks can be examined from time to time (Figure 6.5). Special bottom sampling nets are available for sampling organisms living on the bottom of rivers and lakes.

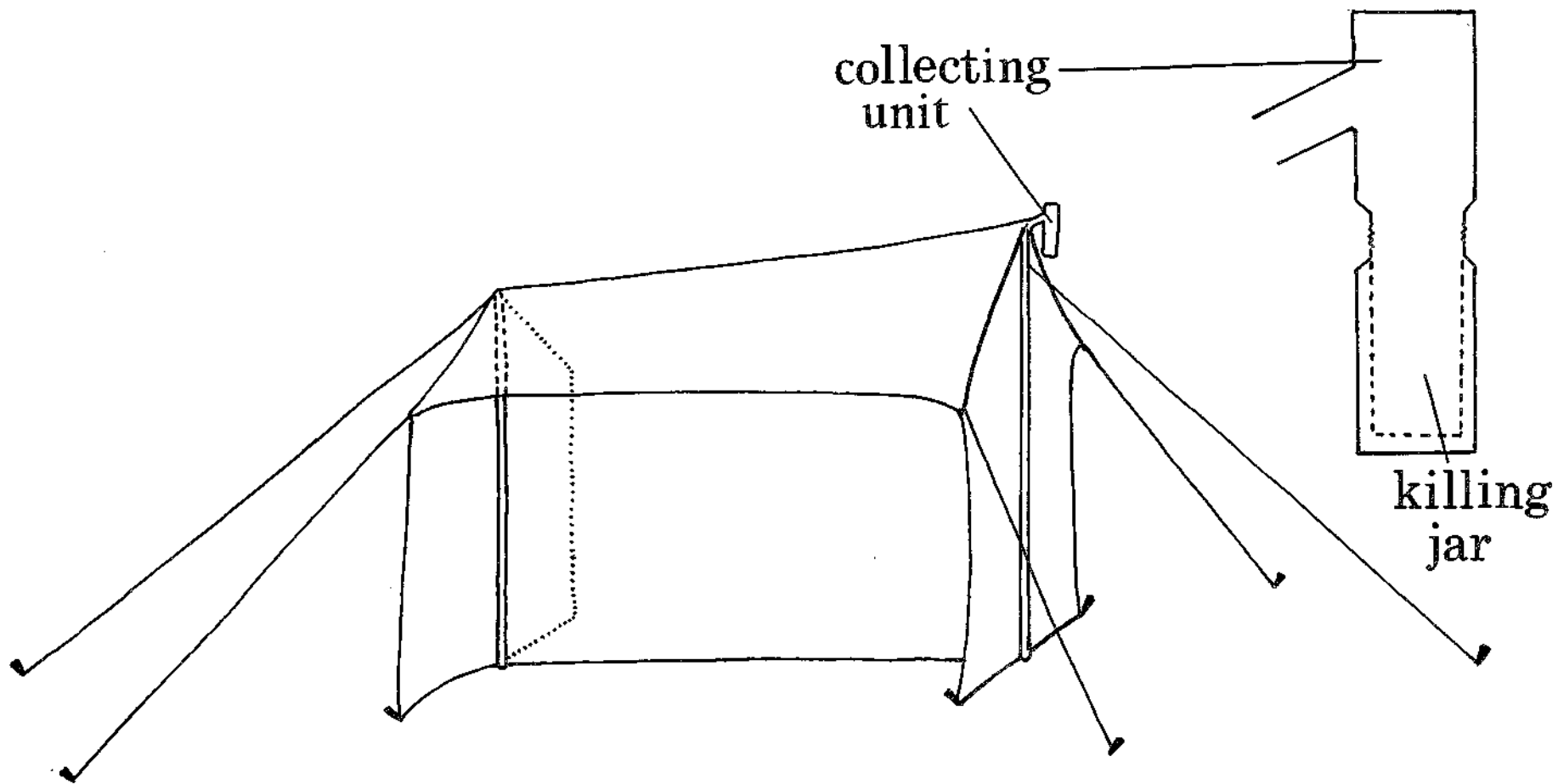

Figure 6.1 One of several possible designs for a Malaise trap, an open-sided tent with a middle wall. Dimensions: length 2 m.; height 2 m. at low end, 2.200 m. at high end; width 1.40 m.

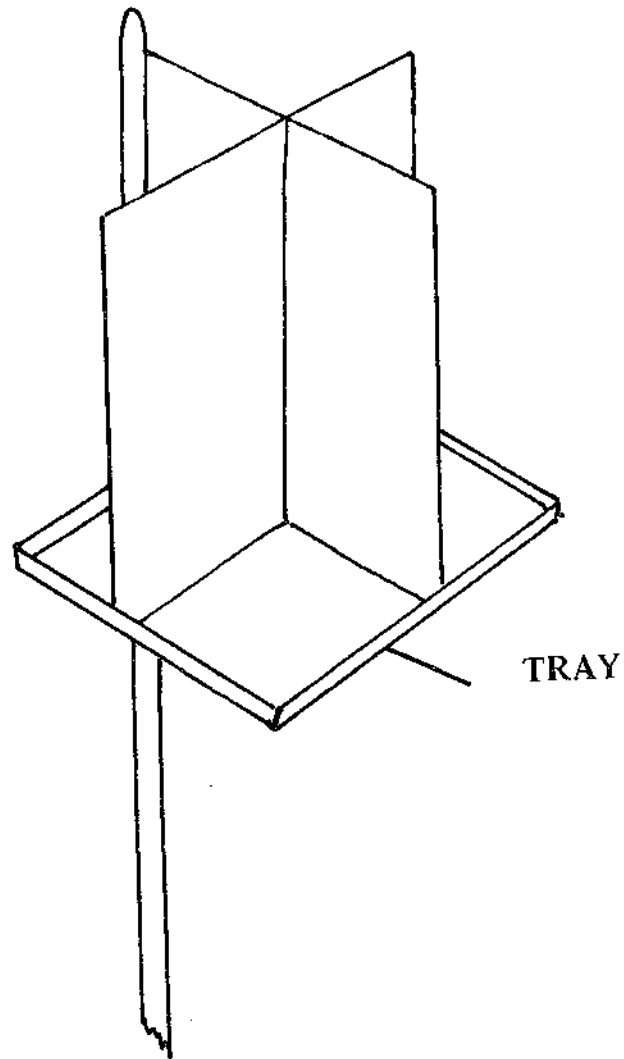

Figure 6.2 A water bath to trap insects. A horizontal tray is fixed to a wooden pole; two metal baffles are placed in the tray as shown. The tray holds water, detergent and formalin (helping to trap and preserve the insects)

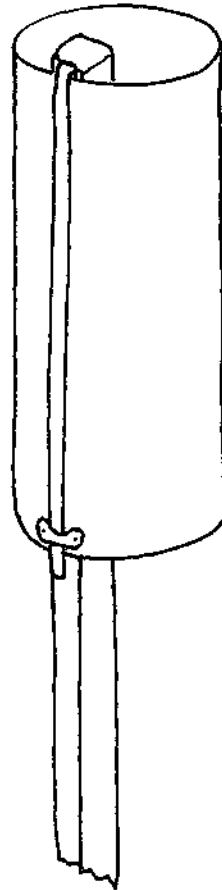

Figure 6.3 A cylindrical sticky trap. A length of pipe is mounted on a wooden stake. Sticky material is wrapped around the pipe and kept in place by a metal clip.

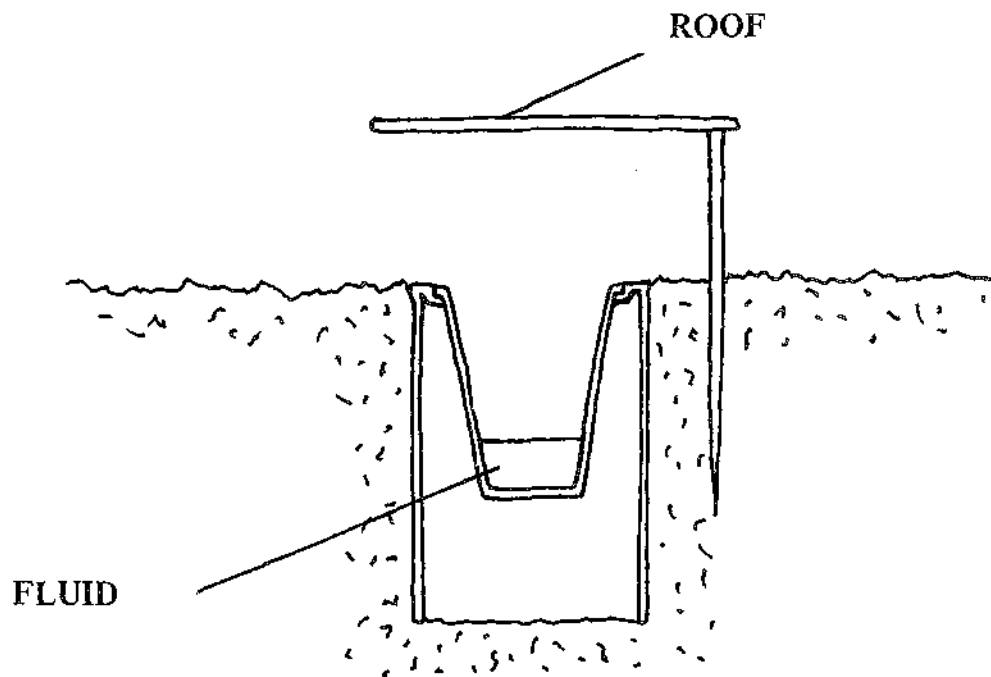

Figure 6.4 A pitfall trap. This design has a roof, and a removable catching vessel containing a water/detergent/formalin mixture.

6.5.2.5 Bioassay Caged insects or water containers with fish or other aquatic organisms can be left exposed in suitable points within the environment to be sprayed, so that the natural situation is imitated as far as possible. This method helps to measure the mortality of organisms resulting from insecticide spraying, and to measure the amount of insecticide getting into the bodies of organisms. For comparison, similar containers should be set up in unsprayed areas.

Studies on the direct effect of insecticides can be carried out in the laboratory on living material brought in from the field, to provide basic data on susceptibility.

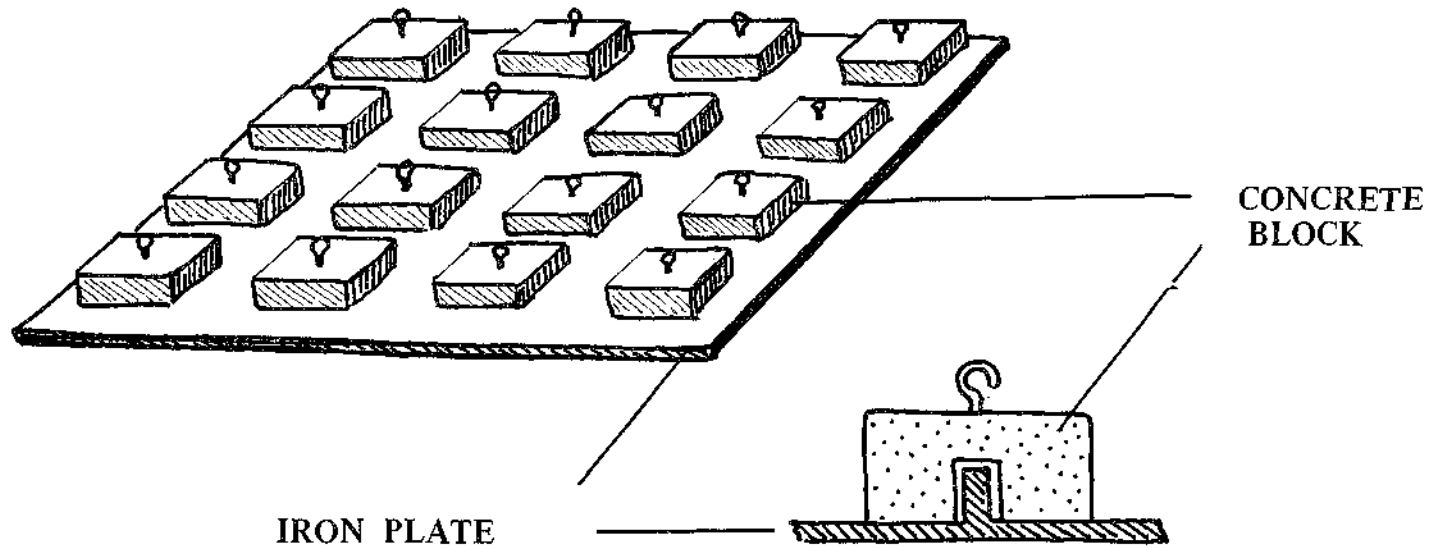

Figure 6.5 Device for studying the numbers of aquatic insects that have a sedentary bottom-living stage. Concrete blocks can be lifted and organisms attached to them examined and counted.

CHAPTER 7

INTEGRATED CONTROL

Integrated control means control by the use of all possible methods to reduce the damage done by the pest.

Campaigns against an agricultural pest may rely on:

- a) insecticides
- b) introduction of varieties of crop plants that have improved resistance to the pest
- c) improved agricultural methods
- d) encouragement of the natural enemies of the pest
- e) genetic methods, such as the sterile male method
- f) use of special attractants and traps

As far as tsetse control is concerned, insecticides are very important and will remain so as far as we can tell. But we should not ignore the other methods of reducing the disease problem, particularly as resistance to insecticides may in the future develop in the tsetse. These other methods include:

- a) using trypanotolerant cattle
- b) using trypanocidal drugs on cattle and other livestock
- c) removing those vegetational communities on which tsetse depend for their permanent dry season habitat. Subsequently, altered patterns of land use will be necessary to prevent regrowth and reinvasion by tsetse.
- d) relocation of villages to reduce man/fly contact, and/or to suppress tsetse in the more densely settled areas

- e) biological methods, involving the release of parasites and pathogens of tsetse
- f) using the sterile male method
- g) improved trapping methods, with some means of chemically attracting tsetses to these traps.

Where possible, one method should not interfere with another, but methods should be integrated so that they work well together. For example, if (in the future) a large scale sterile male release were to be made, this would best be done immediately after a ULV application of a non-residual insecticide. The large numbers of released males would then have to deal with a reduced population, and the insecticide would not have any residual effect against the released flies. On the other hand this method might be dangerous to use in a sleeping sickness area, as the released flies could still act as vectors for the disease, even though they themselves were sterile.

We should think twice before relying on insecticide spraying as the only economical method of tsetse control, in any particular case. Those responsible for organizing a control programme should consider whether any of the other available methods could be used together with or without insecticides.

ACKNOWLEDGEMENTS FOR MAPS AND FIGURES

In addition to those already mentioned in the text, the following acknowledgements are made.

- The tsetse distribution maps are based on Ford and Katondo (1976);
- Map 6.1 (Volume I) is based on de Raadt (1976);
- The following authorities have been followed for the stated figures:

VOLUME I Vale 1971 (Fig. 7.2 A); Swynnerton 1936 (Fig. 7.3); Dame 1978 (Fig 7.4); Jackson 1946 (Fig. 8.5) adapted from a chart by Dr. D.M. Minter (Pers. Comm.) and based on the work of Saunders (1962), Challier (1965) and J.E. Davies (1978); Dr.P.F.L.Boreham (Pers. Comm.) (Fig. 8.7); Burt 1950 (Fig. 8.10).

VOLUME II Waterston 1915 (Fig.1.2A); Turner 1915 (Fig. 1.2B); Austen 1929 (Fig. 1.2C)

RECOMMENDED READING

- Buxton, P.A. (1955). The natural history of tsetse flies
Mem. Lond. Sch. Hyg. Trop. Med. No.10 London
H.K. Lewis.
- Davies, H. (1977). Tsetse flies in Nigeria
Oxford University Press Ibadan.
- Dorst, J. and Dandelot, P. (1972) A field guide to the
larger mammals of Africa.
2nd edition Collins.
- Ford, J. (1971) The role of the trypanosomiasis in
African ecology
Clarendon Press Oxford.
- Glasgow, J.P. (1963). The distribution and abundance of
tsetse
Pergamon Press Oxford.
- Hoare, C.A. (1972). The trypanosomes of mammals: a
zoological monograph
Blackwell
- Laird, M. (1977). Tsetse: the future for biological
methods of integrated control
IDRC, Ottawa, Canada
- McKelvey, J.J. (1973). Man against tsetse
Cornell University Press
- Meteorological Observers' handbook, H.M.S.O. London
- Mulligan, H.W. (1970) The African Trypanosomiasis
Ministry of Overseas Development/George Allen and Unwin.
- Nash, T.A.M. (1969) Africa is bane: the tsetse fly
Collins.
- Ryan L. and Molyneux (1980). Construction details of
the Challier/Laveissiere Biconical Trap
in Isotope and Radiation Research on Animal Diseases
and their Vectors. IAEA, Vienna 1980

- Smith, K.G.V. (1973). Insects and other arthropods of medical importance
British Museum (Natural History)
- Southwood, T.R.E. (1978). Ecological methods
Second edition Chapman and Hall
- Swynnerton, C.F.M. (1936). The tsetse flies of East Africa
Trans R. ent. Soc. Lond. 84, 579
- Jordan, A.M. (1986). Trypanosomiasis Control and African Rural Development. Longman, London and New York.

APPENDIX IClassification of animals mentioned in the Manual

<u>Phylum</u>	<u>Class</u>	<u>Order</u>	<u>Family</u>	<u>Examples</u>
Vertebrata	Mammalia	Macroscelidea		Elephant shrew
		Chiroptera		Bats
		Primates		Monkey, baboon, man
		Tubilidentata		Aardvark
		Proboscidea		Elephant
		Perissodactyla		Rhinoceros, horse, zebra
		Artiodactyla		
			Suidae	Domestic pig, bush pig, red river hog, giant forest hog
			Hippopotam- idae	Hippopotamus
			Giraffidae	Giraffe
			Camelidae	Camel
			Bovidae	Bovines such as buffalo and ox (cattle) Other bovids such as antelopes (bushbuck, kudu, eland, waterbuck, reedbuck, etc.) and duikers

Classification of animals mentioned in the Manual (contd)

<u>Phylum</u>	<u>Class</u>	<u>Order</u>	<u>Family</u>	<u>Examples</u>
		Rodentia		Porcupine, squirrel
	Aves (birds)			Flycatchers, kingfishers, thrush, robin chat, cormorant
	Reptilia			Crocodile, monitor lizard, snakes
Vertebrata	Amphibia			Frogs and toads
	Pisces (fish)			
Arthropoda	Insecta	Orthoptera		Locust
		Isoptera		Termites
		Ephemeroptera		May-flies
		Odonata		Dragon-flies
		Hemiptera		Bugs
		Lepidoptera		Moths, butterflies
		Coleoptera		Beetles
		Diptera	Culicidae	Mosquitoes
			Asilidae	Robber flies
			Tabanidae	Horse flies
			Bombyliidae	<u>Thyridanthrax</u>
			Syrphidae	Hover flies
			Muscidae	<u>Stomoxys</u>
			Glossinidae	<u>Glossina</u> (tsetse)
			Hippoboscidae	Louse flies

Classification of animals mentioned in the Manual (contd)

<u>Phylum</u>	<u>Class</u>	<u>Order</u>	<u>Family</u>	<u>Examples</u>
		Hymenoptera		Parasitic wasps (<u>Mutilla</u> , <u>Syntomosphyrum</u>) Wasps (<u>Bembex</u>) Ants Honey bee
	Arachnida	Araneae		Spiders
	Crustacea			Shrimps
Aschelminthes				Nematodes
Protozoa				<u>Trypanosoma</u>

APPENDIX IICommon names and scientific names of selected
African wild mammals

<u>Common name</u>	<u>Scientific name</u>
Aardvark (ant bear)	<u>Orycteropus afer</u>
Antelope	
Sable	<u>Hippotragus niger</u>
Roan	<u>Hippotragus equinus</u>
Buffalo	<u>Syncerus caffer</u>
Bushbuck	<u>Tragelaphus scriptus</u>
Bush-pig (and red river hog)	<u>Potomachoerus porcus</u>
Duiker	<u>Cephalophus spp</u>
Eland	
Giant eland	<u>Taurotragus derbianus</u>
Livingstone's eland (Cape eland)	<u>Taurotragus oryx</u>
Elephant	<u>Loxodonta africana</u>
Elephant shrew	<u>Macroscelid</u>
Giraffe	<u>Giraffa camelopardus</u>
Hartebeest	
Bubal or red hartebeest	<u>Alcelaphus buselaphus</u>
Lichtenstein's harte- beest	<u>Alcelaphus lichtensteini</u>
Hippopotamus	<u>Hippopotamus</u>
Hog	
Giant forest hog	<u>Hylochoerus meinertzhageni</u>
Red river hog	<u>Potomachoerus porcus</u>
Impala	<u>Aepyceros melampus</u>
Kudu	
Greater kudu	<u>Tragelaphus strepsiceros</u>
Lesser kudu	<u>Tragelaphus imberbis</u>
Leopard	<u>Panthera pardus</u>
Lion	<u>Panthera leo</u>
Porcupine	<u>Hystrix spp</u>
Reedbuck	<u>Redunca redunca</u>
Rhinoceros	
Black rhinoceros	<u>Diceros bicornus</u>
White rhinoceros	<u>Ceratotherium simum</u>
Sitatunga	<u>Tragelaphus spekei</u>

Common names and scientific names of selected
African wild mammals (contd)

<u>Common name</u>	<u>Scientific name</u>
Sitatunga	<u>Tragelaphus spekei</u>
Topi (tiang, korrigum)	<u>Damaliscus korrigum</u>
Warthog	<u>Phacochoerus aethiopicus</u>
Waterbuck	
Common waterbuck	<u>Kobus ellipsiprymnus</u>
Defassa waterbuck	<u>Kobus defassa</u>
Wildebeest	<u>Connochaetes taurinus</u>
Zebra	
Burchell's	<u>Equus burchelli</u>
Grevy's	<u>Equus grevyi</u>

APPENDIX IIIBiting flies other than Glossina

Tsetse control personnel should be familiar with biting flies other than Glossina. They should understand that members of the public may confuse these flies with the tsetse, and that people may therefore report the presence of tsetse where it does not exist.

Small biting flies such as mosquitoes and Simulium are not described here as they are unlikely to be misidentified as tsetse.

Three main groups of biting flies are described below, so that they may be distinguished from Glossina.

1. Stomoxys and its close relatives

The following are the main points of difference from Glossina:

- i) At rest the wings are not folded one over the other, but project at an angle to the body.
- ii) The veins of the wing do not make 'hatchet cell'; vein 1 is not very long; veins 2 and 3 are not very close to one another.

2. Hippobosca and its close relatives

The following are the main points of difference from Glossina:

- i) The general appearance of the body is rather flat and tick-like. The legs are spread out to the sides.
- ii) The veins of the wing do not make a 'hatchet cell'; vein 1 is not very long; veins 2 and 3 are not very close to one another.

3. Tabanids (horse flies, buffalo flies)

These biting flies all belong to the family Tabanidae. The following are the main points of difference from Glossina:

- i) At rest the wings are not folded one over the other, but form a kind of angled roof over the abdomen.
- ii) The veins of the wing do not make a 'hatchet cell'. The wings may be coloured with dark or cloudy patches (but many tabanids have clear wings).

Conversion TableLength

1 mm = 100 μ m
1 m = 1000 mm
1 km = 1000 m
1 m = 1.093 yd
1 ft = 0.305 m
1 yd = 0.914 m
1 mile = 1.609 km
1 km = 0.621 mile

Area

1 ha = 10,000 m²
1 km² = 100 ha = 0.386 mile²
1 mile² = 259 ha = 2.59 km²

Volume

1 l = 0.22 Imp. gal.
1 Imp. gal. = 4.55 l.

Mass (weight)

1 kg = 2.2 lb
1 lb = 0.454 kg.

G L O S S A R Y

- Abortion: Expulsion of egg in larva from the uterus before it is mature, leading to its death.
- Active ingredient (a.i.): Pure insecticide.
- Aerosol: Spray with droplets of 50 μm diameter or less.
- Amino acid: Unit of the protein molecule.
- Amphibian: Frogs and toads, and related animals.
- Anemometer: Instrument used to measure wind speed.
- Apparent density: The number of non-teneral males caught per 9 000 m (10 000 yards) by a catching party.
- Arboricide: Chemical used to kill trees.
- Atypical habitat: An unusual tsetse habitat, often around villages or in plantations.
- Bait animals: Animals used to attract tsetse.
- Bias (of sample): An inaccuracy of sampling, which gives a distorted picture of the population from which the sample came.
- Bioassay: A technique by which animals are exposed to insecticides in order to test and measure the effectiveness (or quantity) of the insecticides.
- Breeding sites: Points at which tsetse pupae are to be found.
- Buttress root: Strong vertical rib of wood at the base of tree trunk.
- Canopy: The upper branches and leaves of a tree, the part that throws the greatest shade.
- Census: A count made of a population of animals.
- Chancre: A hard disc in the skin that forms in the skin of some sleeping sickness patients, at the point where an infected fly pierced the skin to suck blood.
- Chemical barrier: An area in which as much as possible of the woody vegetation is sprayed, as a barrier to tsetse advance. It may be put down to check the return of tsetse into a zone previously cleared of tsetse, or to check a spontaneous advance of a fly belt.
- Chronic disease: A disease that persists in the patient for a long time.
- Cold-blooded vertebrates: Fish, amphibians and reptiles.
- Concentration area: Area in which tsetse flies may be specially numerous.

- Control: Reduction in pest numbers by spraying or other means, without necessarily achieving eradication.
- Corridor clearing: Bush clearing along the sides of roads, paths and railway tracks in order to reduce the chance of traffic carrying tsetse flies from one region to another.
- Cyclical transmission: Transmission (passing on) of a parasite (e.g. Trypanosoma) from one host to another, involving a delay during which the parasite undergoes a period of reproduction in the vector. In the case of tsetse, the vector then remains infective for the rest of its life.
- Dambo (= mbuga): A wet grassy clearing with few or no trees, within uniform woodland such as miombo.
- Density: Number of flies per unit area.
- Derived savanna: Savanna which has formed by the removal of the original forest.
- Discriminative spraying: Spraying limited to certain parts of the tsetse habitat, for example gallery forest especially along river banks.
- Discriminative bush clearing: Bush clearing limited to certain parts of the tsetse habitat, e.g. dambo edges, known or thought to be concentration areas.
- Dispersal (of tsetse): The spread of tsetse flies throughout their habitat.
- Dispersant: A substance present in an emulsifiable concentration formulation, to help it produce an even, stable emulsion when mixed with water.
- Distribution: The broad areas in which a tsetse species is to be found. The distribution may be given as a list of countries, or may be marked out on a map (distribution map).
- Down current: A downward rush of wind.
- Down wash: The downward draught from a helicopter.
- Drift net: A net that hangs still in the water, catching fish that swim into it, by the gills.
- Droplet: A small drop of insecticide spray.
- Drug: A medicine.
- Ecology: The study of how animals and plants react on one another, and with the soil, climate and other environmental factors.
- Ecotone: Area of transition between one main vegetation type and another.
- Emigration: Movement of tsetse flies away from an area.

Emulsifiable concentrate: A concentrated solution of insecticide in oil, formulated so that it will form an emulsion when diluted with water.

Endemic disease: A disease that remains present in an area, with only occasional cases.

Environment: All the factors that affect the life of an animal or plant, e.g. other organisms, soil, climatic factors.

Enzyme: A chemical substance produced by organisms, helping to alter the rate of processes going on in the body.

Epidemic disease: A disease that is present at a high level or is capable of quickly infecting large numbers of people.

Epidemiology: The study of how diseases are transmitted, and what makes the numbers of cases rise and fall.

Eradication: Total elimination (of tsetse) from an area.

Escarpment: A steep slope, connecting level low land and level high land.

Evergreen: Not losing all its leaves in one particular season.

Faeces: Droppings.

Fluorescent powder: Powder that glows brightly when an ultra-violet light is shone upon it.

Fogging: A method of space spraying, by using a blast of hot air to make insecticide smoke.

Following swarm: A group of tsetse flies, consisting mainly of non-teneral males. They follow an animal (or man) by means of short flights, settling on the ground or on near-by vegetation, or on the animal being followed.

Formulation: The exact concentration and mixture of substances present in an insecticidal material as purchased.

Gallery forest: Forest growing along the banks of streams and rivers, flowing through savanna zones.

Genitalia: The structures at the rear end of the abdomen used for mating.

Habitat: That part of the whole environment in which an animal or plant species lives.

Haemolymph: Insect blood.

Head-up position: A position with the head towards the sky - a position that a settled tsetse fly may take up when it lands on a person or an animal.

Histogram: A diagram to show by the height of rectangles, changes in the size of one variable in respect of another.

- Holding line: A zone set up to halt the advance of a fly belt. It may consist of a wide strip of bush clearing and game elimination, and of fences.
- Host: An animal that provides blood meals for tsetse.
- Humidity: Amount of water vapour held in the air.
- Humus: Decaying plant material present in or on the soil.
- Hunger staging: Examining the abdomen of male tsetse flies to determine by its appearance (colour, degree of swelling) the stage of digestion of the last blood meal.
- Immigration: Movement of tsetse flies into an area.
- Insecticide: Any substance poisonous to insects, and used for the purpose of insect control.
- Insectivorous birds: Birds whose main diet consists of insects.
- Insemination: Transferring sperm from the male to the female.
- Integrated control: Control of a pest by the careful use of all available methods, to their maximum effect.
- Mbuga (see Dambo)
- Nagana: Cattle trypanosomiasis
- Navigation: Finding one's way around the country by means of maps, compass and other instruments.
- Non-persistent insecticide: An insecticide that does not remain effective for long periods after spraying.
- Non-target organisms: Organisms not intended to be destroyed by insecticide spraying.
- Non-teneral: Flies that have taken their first blood meal, and have developed a thorax that is firmer to the touch.
- Nozzle: The part of the spraying machinery which carries the aperture through which the spray comes.
- Opportunistic feeding: Feeding by tsetse, in which the hosts are selected more by their availability than by any special preference on the part of the tsetse.
- Ovarian analysis: Examination of the ovaries of tsetse by dissection, to estimate the age of the fly.
- Ovulation: Movement of a new egg into the uterus.
- Pathogenic: Causing disease.
- Persistent insecticide: An insecticide remaining effective for a long time after spraying.
- Pollution: Putting poisons and other destructive substances into the environment.

Radio-activity: The giving off of invisible radiations that can, with suitable instruments, be detected at a distance from the source.

Reclamation: Eradication of flies from an infested area so that the land becomes available for development.

Reservoir (of infection): A persistent source of fresh infection.

Residual insecticide: An insecticide that acts by insects coming into contact with traces (residues) of the insecticide persisting in the parts that have been sprayed.

Resistance (to insecticides): Ability of strains of insects to resist insecticides, and to survive insecticide attack.

Respiration: Release of energy from food material.

Resting sites: Places within the habitat that are selected by tsetse flies for resting for long periods.

Run-off: Loss of spray by putting too much on to too limited a surface, so that instead of sticking to the surface it dribbles to the ground and is wasted.

Sahel zone: Very dry zone with generally low vegetation in which palpalis group flies are at their extreme northern limit along streams and rivers.

Selective spraying: Spraying limited to certain parts of the vegetation known to be used as resting sites by tsetse.

Selective bush clearing: Clearing away certain species of trees, but leaving the rest.

Solvent: Liquid in which something is dissolved.

Specificity (of insecticide activity): Effective toxic action of insecticide against one species rather than another.

Strain: A variety or type which is different from what is normal for the species.

Suspension: A mixture in which very small solid particles are spread evenly throughout a liquid (usually water).

Swath: A band of insecticide droplets as put out by a spraying machine.

Systematics: The ordered arrangement of species, usually on the basis of their relatedness to each other.

Temperature inversion: An atmospheric condition in which the higher layers of air are warmer than the layers of air close to the ground.

Teneral flies: Flies that have recently emerged from the pupa, and have not yet had their first meal. The thorax is rather soft (soapy) to the touch.

Toxicity: Poisoning effect.

Trypanosomiasis: Disease caused by pathogenic trypanosomes.

Trypanotolerant (cattle): Cattle able to survive moderate exposure to pathogenic trypanosomes, without suffering from serious disease.

Ultra-low volume (ULV) spray: A formulation of a pesticide in oil solvents applied undiluted at volume rate of less than 5 l/ha.

Ultra-violet lamp: A lamp that puts out mainly invisible rays that cause fluorescent paints to glow in the dark.

Vector: An organism (often an insect) that carries disease from one host to another. It usually involves some reproduction of the pathogen in the vector organism.

Virus: An organism, smaller than a bacterium, that lives as a parasite within other organisms.

Water dispersible powder (WDP) or wettable powder (wp): A powder that mixes easily with water to form a stable suspension.

Watershed: A line of high ground lying between two river systems.

